

Installation, Operation and Maintenance Manual

Please read and save these instructions for future reference. Read carefully before attempting to assemble, install, operate or maintain the product described. Protect yourself and others by observing all safety information. Failure to comply with instructions could result in personal injury and/or property damage!



Product Specification

Digital Temperature Interlock

International Mechanical Code (IMC) 2006 section 507.2.1.1 Compliant Electrical Package

Provide Accurex temperature interlock electrical package as shown on plans and in accordance with the following specification:

The temperature interlock(s) consists of a temperature controller, resistive temperature detector (RTD), junction box, fire proof/leak proof threaded fitting (Evergreen Quik-Seal[®] and/or Evergreen Compression Seal), and shall be a self-contained unit or as part of another pre-engineered electrical control package.

The temperature interlock package shall close a relay powering the fans when the sensor detects the temperature set point. The interlock shall hold the circuit closed upon fan switch being turned off until the temperature sensor detects a temperature below the set point plus hysteresis. Once the temperature is below the set point plus hysteresis, the fans shall shut down.

The temperature interlock package shall be constructed by Accurex in accordance with International Mechanical Code. The manufacturer shall provide, upon request, the necessary data that confirms compliance with the code listed above.

Due to continuous research, Accurex reserves the right to change specifications without notice.

General Description

Description

The temperature interlock is designed to automatically start kitchen hood exhaust fans and keep them running while heat is being generated from the cooking appliances. Hood systems should always be manually started before equipment is turned on. If the fans are forgotten to be turned on, the interlock will turn the fans on once heat is detected. The interlock consists of a temperature controller, resistive temperature detector (RTD), junction box, Evergreen Compression Seal threaded fitting, and is contained in a stand alone box or can be added to a pre-engineered fan control center.

Purpose

To meet IMC 2006 section 507.2.1.1, interlock between exhaust fans and cooking equipment. This system will utilize a temperature sensor in the exhaust duct collar or in capture area of hood to detect heat generated from cooking operations and automatically activate the exhaust fans if not already turned on. Field wiring may be required depending on location of components.

Product Application

The temperature interlock is designed to be used with Type I and Type II hoods. It is not to be used in conjunction with exhaust fire dampers. Accurex recommends using one interlock per hood system (activates all fans linked to system simultaneously).

Performance Goals

Automatically energize the exhaust fans when cooking equipment generates heat. Basic controls will be provided with a temperature sensor and will consist of an 8 x 8 electrical box with controls and a labeled terminal strip to hook-up incoming power and fan starters. A temperature controller is used to keep the exhaust fans running when the temperature controller initially closes to prevent the fan from cycling on and off at startup and shut down. Fans will shut down automatically once the temperature has gone below the set point plus hysteresis. The hysteresis can be adjusted based on jobsite requirements.

Table of Contents

Product Specification	1
General Description	1
Receiving and Handling	2
Installation	
Hood Mounting	2-3
Duct Collar Mounting	3
Electrical Connections	
Sensor Connections	3
Switch Connections to Control Box or Fan Control Center	3
Circuit Connections	3
Calibration	4
Factory Selected Parameters	
Setting Parameters	3-4
Control Circuit Diagrams	5-6
Testing	7
Operation	7
Troubleshooting	7
Maintenance	7
Frequently Asked Questions	8
Replacement Parts	8
Codes and Standards Compliance	8
Our Commitment	8

Receiving and Handling

Upon receiving the equipment, check for both obvious and hidden damage. Check to be sure that all parts of the shipment, including accessories, are accounted for. Make sure the equipment does not suffer any heavy vibrations or knocks.

Storage

If a temperature interlock must be stored prior to installation, it must be protected from dirt and moisture. Indoor storage is recommended. For outdoor storage, cover the control package with a tarp to keep it clean, dry, and protected from UV (ultraviolet) radiation damage.

Improper storage which results in damage to the unit will void the warranty.

Installation

Control Box Mounting

Locate an area with enough space to mount the control box and fasten to the wall. Avoid installing the control box in environments with high magnetic and/or radio frequency interference.

NOTE

Control box may be factory mounted. If so, continue to the next section.

Resistive Temperature Detector(s) Hood Mounting

NOTE

Resistive temperature detector(s) may be factory installed. If so, continue to the next section.

1. Locate flat area(s) at the top interior of the hood in front of the filters, towards the front of the hood.

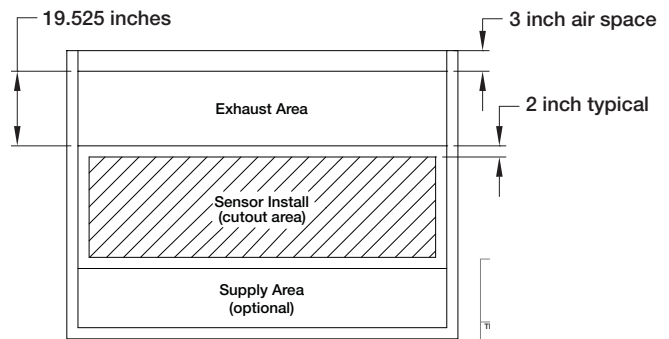

Top View of Exhaust Hood

2. Cut a 3/4 to 7/8-inch diameter hole in the flat spot of the capture tank. Make sure the resistive temperature detector(s) will not interfere with fire system nozzles and is not within 12 inches of light fixtures.

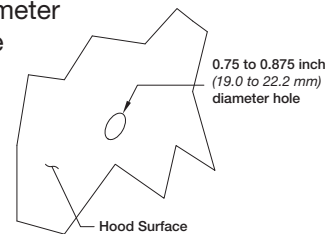

3. Place the J-box plate inside of the octagon extension ring and place over the hole.
4. Disassemble the compression seal and place through hole and J-box plate as shown. Tighten the nut inside the octagon extension ring.

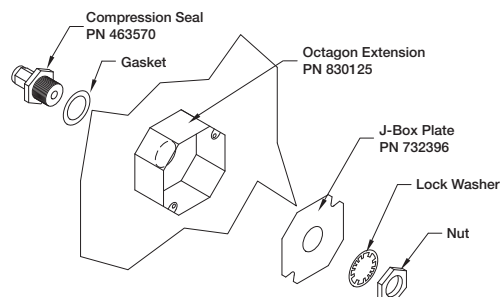

- Place the resistive temperature detector through the compression seal and tighten the compression fitting.
- Refer to Electrical Connections section for instructions on wiring the temperature sensor.
- Install the cover for the octagon box.

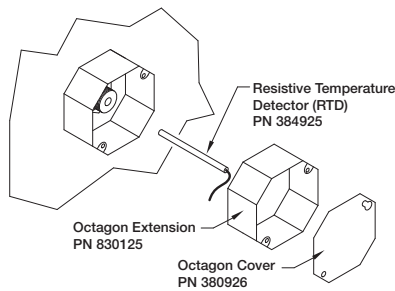

Resistive Temperature Detector(s) Duct Collar Mounting

- Locate the exhaust duct on top of the hood. A 3/4 to 7/8-inch (19.0 to 22.2 mm) diameter hole must be cut into the duct 2 inches (50.8 mm) above the hood top. Center the hole along the side of the duct. Make sure that the resistive temperature detector will not interfere with any fire system nozzles, or other items installed in the exhaust duct. If an exhaust fire damper is present the hood exhaust collar, it must be removed prior to temperature sensor installation.

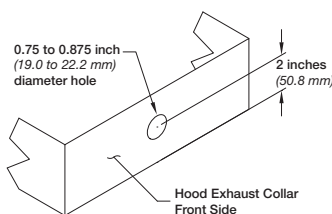

- Place the J-box plate inside of the octagon extension ring and place over the hole in the exhaust collar.
- Disassemble the compression seal and place through hole in duct collar and J-box plate as shown. Tighten the nut inside the octagon extension ring.

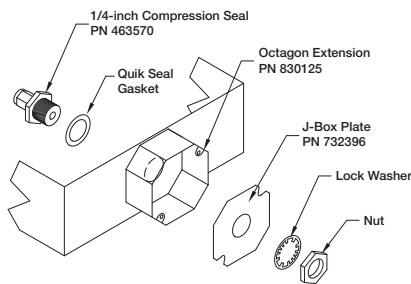

- Place the resistive temperature detector through the compression seal and tighten the compression fitting.
- Refer to Electrical Connections section for instructions on wiring the temperature sensor.
- Install the cover for the octagon box.

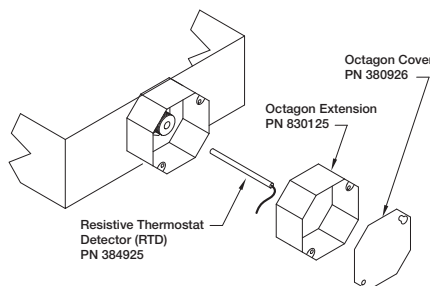

NOTE

All field installation and wiring of electrical equipment must be done to meet NEC and local codes.

Electrical Connections

Sensor Connections

- Run two 18 awg stranded thermostat wires from each temperature sensor to the appropriate electrical circuit connections. (See Step 3 for connection options).
- In junction box, connect leads on RTD to the 18 awg conductors using appropriate size wire nuts.
 - Wires are interchangeable with one another.
- Choose the final connection option based on:

Sensor	Terminals
First Sensor	T1-A and T1-B
Others (if applicable)	T2-A and T2-B T3-A and T3-B T4-A and T4-B T5-A and T5-B T6-A and T6-B T7-A and T7-B T8-A and T8-B T9-A and T9-B T10-A and T10-B T11-A and T11-B T12-A and T12-B

CAUTION

Do not connect temperature sensor in series with fan power. This will result in damage to the temperature sensor and will require replacement.

NOTE

Separate as much as possible the probe and digital input cables from inductive loads and power cables, to avoid any electromagnetic disturbance. Never lay power and probe cables in the same cable conduits (including those for the electrical panel). Loosen every screw and insert the cable end, next tighten the screws and gently pull the cables to check their tightness.

Switch Connections to Control Box or Fan Control Center

Connect a Single Pole Single Throw (SPST) switch to terminals S1H and S1. This is the same whether temperature interlock is in a separate control box or integrated in a kitchen fan control center.

Circuit Connections

- Standard Interlock Control
 - 120VAC, 10 or 15 amp circuit to terminals H1 and N1
 - 120VAC, 24VAC or other control circuit for fan starter activation (factory separated from main power connection shown in previous bullet)
 - Control circuit power to terminal CP1
 - Terminal CP2 to fan starter coils (hot)
- Kitchen Fan Control Center Integration (XFCC)
 - 120VAC, 15 amp circuit to H1 and N1 in fan control center
 - No additional control circuits are required
 - Fan starters are factory-wired.



Calibration

The temperature controller is preset by the factory to turn the fans on at 95°F. This is controlled by the set point on the temperature controller. The temperature set point may have to be adjusted slightly depending on both ambient and cooking conditions. The adjustment is made through the buttons on the temperature controller. The controller is capable of monitoring two separate sensors. If more than one sensor is utilized with a single controller, two set points can be adjusted. To adjust, follow these instructions:

1. If setting set point 1 (St1), press **Set**. The display shows St1 and then the current value of St1.
If setting set point 2 (St2), press **Set** twice, slowly. The display shows St2 and then the current value of St2.
2. Press the ▲ or ▼ to change the set point.
3. Press **Set** to confirm the new value of either St1 or St2.
4. Check system operation before making additional adjustments.

Factory Selected Parameters

The factory will pre-program the controllers to be properly integrated into the control panel. Except for the set points, the other parameters should never need adjusting. However, there are three different types of parameters that are accessible on the controller. Access differs depending on the type: set point; frequently used parameters (P); and configuration parameters (c, d, F).

NOTE

The controller is pre-programmed at the factory to operate with the digital temperature interlock components. No further parameter changes should be necessary.

Setting type P parameters

Type P parameters (frequent) are indicated by a code beginning with the letter P, followed by one or two numbers.

1. Hold the **Prg** button, after 3 seconds the display shows the firmware revision code (e.g. r2.1) is shown, after 5 seconds (in the event of alarms, first the buzzer is muted) the code of the first type P modifiable parameter, P1.
2. Press ▲ or ▼ until reaching the desired parameter.
3. Press **Set** to display the associated value.
4. Increase or decrease the value using ▲ or ▼ respectively, until reaching the desired value.
5. Press **Set** to temporarily save the new value and return to the display of the parameter code.
6. Repeat operations from 4 to 5 to set other parameters.
7. To permanently save the new values of the parameters, press **Prg** for 5 seconds, thus exiting the parameter setting procedure.

Setting type c, d, F parameters

Type c, d or F (configuration) parameters are indicated by a code beginning with letters c, d, F respectively, followed by one or two numbers.

1. Press **Prg** and **Set** together for more than 5 seconds. The display shows the number 0.
2. Press ▲ or ▼ until displaying the password: 77
3. Confirm by pressing **Set**
4. If the value entered is correct, the first modifiable parameter c0 will be shown, otherwise the standard display will resume.
5. Press ▲ or ▼ until reaching the parameter to be modified.
6. Press **Set** to display the associated value.
7. Increase or decrease the value using ▲ or ▼ respectively, until reaching the desired value.
8. Press **Set** to temporarily save the new value and return to the display of the parameter code.
9. Repeat operations from 5 to 8 to set other parameters.
10. To permanently save the new values of the parameters, press **Prg** for 5 seconds, thus exiting the parameter setting procedure.

Factory Selected Parameters		
Parameter	Description	Factory Setting
St1	Set Point 1	95
St2	Set Point 2	95
c0	Operating Mode	1
P1	Set Point Differential	5.0
P2	Set Point Differential	5.0
P3	Dead Zone Differential	0
c6	Delay between two outputs	0
c9	Minimum relay on time	5
c10	Probe alarm output status 1	1
d10	Probe alarm output status 2	1
c11	Output Rotation	4
c13	Probe Type	3
P14	Probe 1 Calibration	0
P15	Probe 2 Calibration	0
c18	Unit of Measure	1
c19*	Function of probe 2	0 or 7

*Parameter c19 is factory set at 0. If controller is connected to two sensors, then the parameter is factory set at 7..

Displaying the Inputs

1. Press ▼. The current input will be displayed, alternating with the value:
b1 : probe1
b2 : probe 2
di1 : digital input 1
di2 : digital input 2
St1 : set point 1
St2 : set point 2
2. Press ▲ or ▼ to select the input to be displayed.
3. Press **Set** for three seconds to confirm.



Control Circuit Diagram (Standard Control)

This is an example of a generic wiring diagram for standard control. This diagram has 12 sensors which provide temperature interlock function for two exhaust fans and one supply fan. (All starters provided by others, external to this control box).

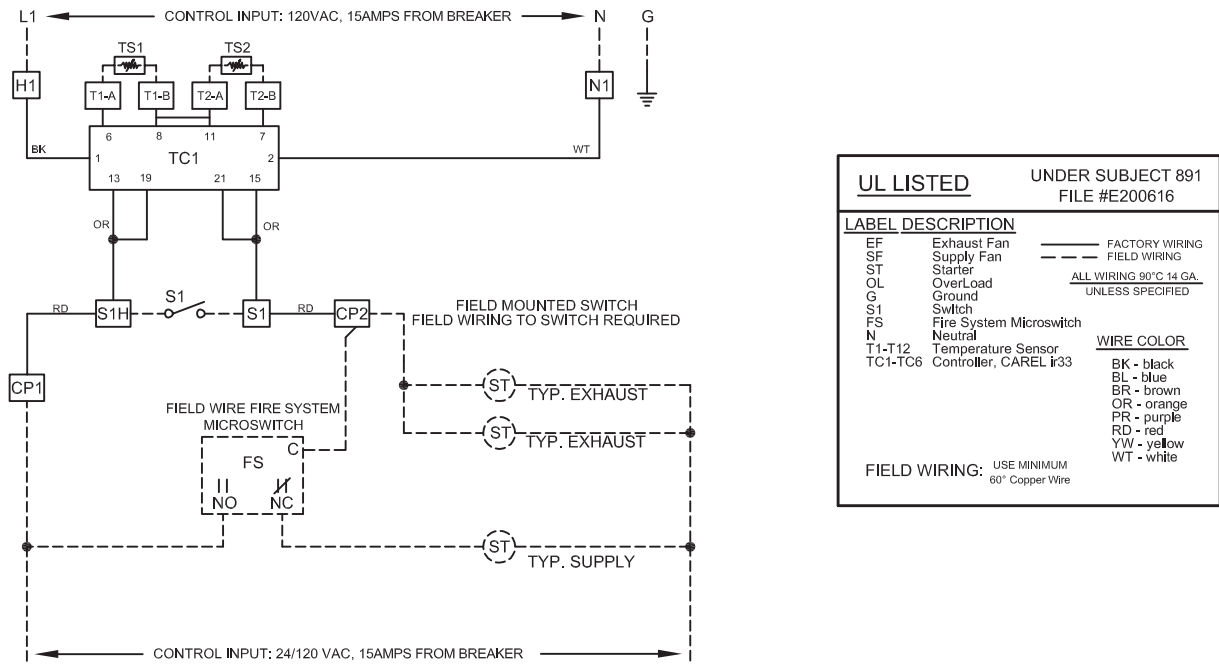

Wiring for additional sensors (optional)

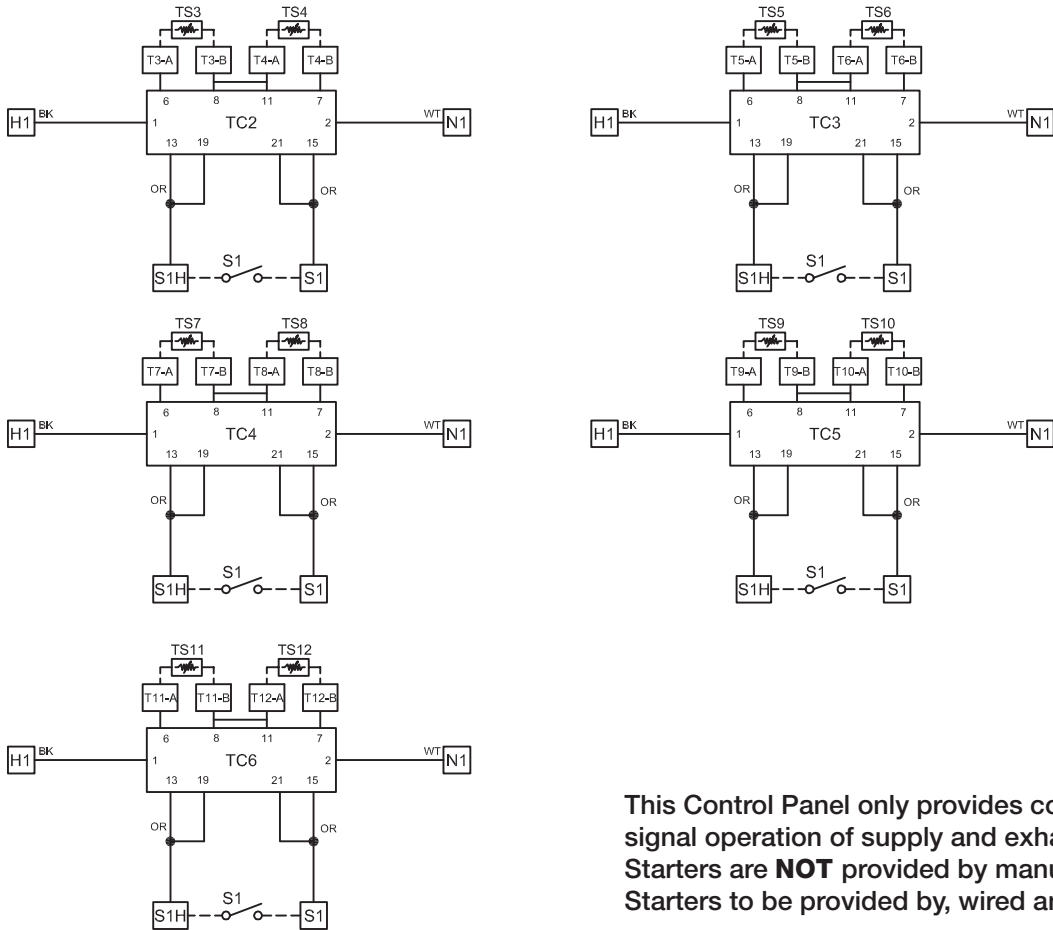

This Control Panel only provides control power to signal operation of supply and exhaust starters. Starters are **NOT** provided by manufacturer. Starters to be provided by, wired and mounted by others.



Control Circuit Diagram (Fan Control Center)

This is an example of a generic wiring diagram for temperature interlock integration into a XFCC. This diagram has 2 sensors that provide temperature interlock function for one exhaust fan and one supply fan. To see your job specific drawing, look on the inside panel of the XFCC cabinet.

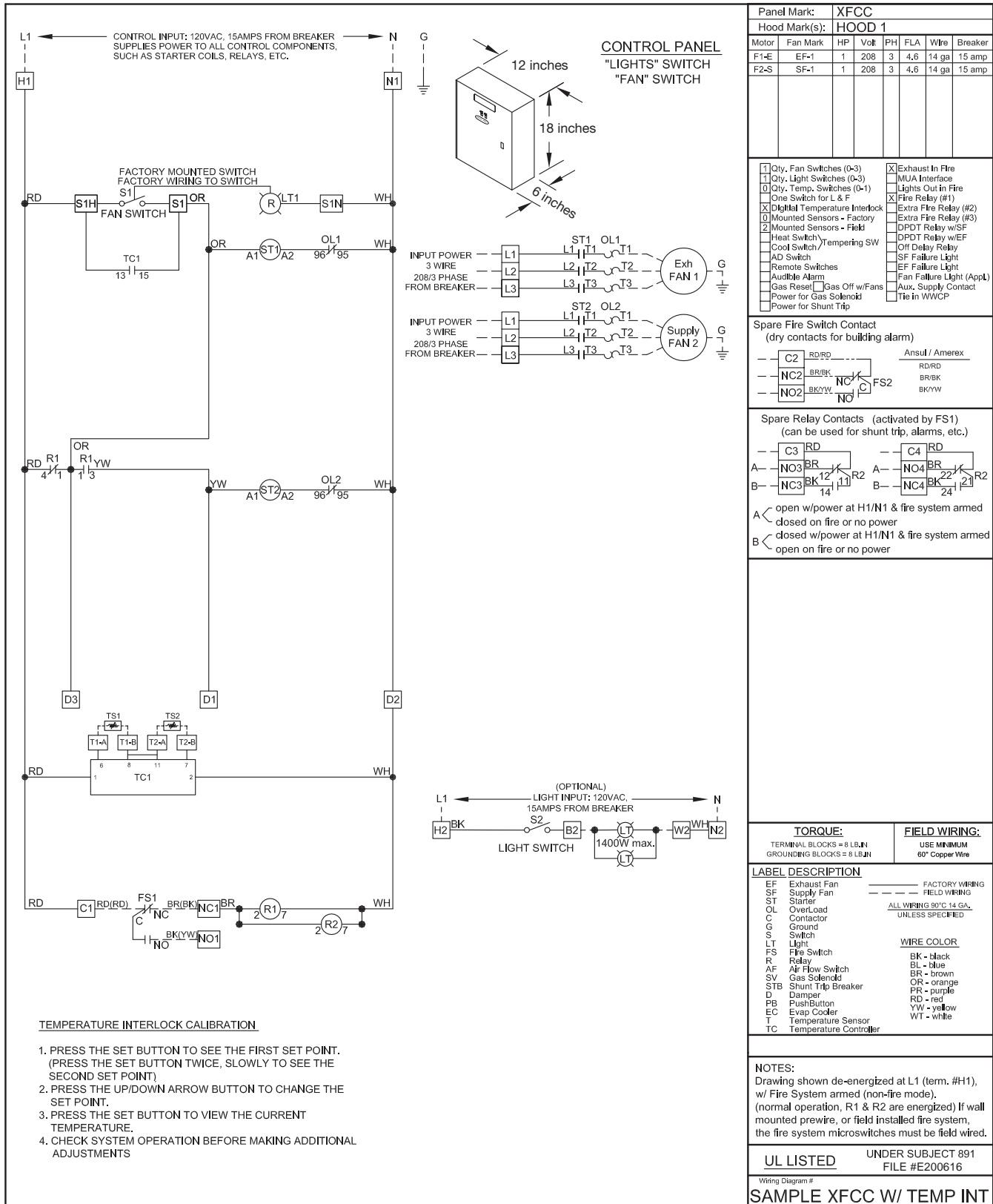

Panel Mark:	XFCC						
Hood Mark(s):	HOOD 1						
Motor	Fan Mark	HP	Volts	PH	FLA	Wire	Breaker
F1-E	EF-1	1	208	3	4.6	14 ga	15 amp
F2-S	SF-1	1	208	3	4.6	14 ga	15 amp

<input type="checkbox"/> Qty. Fan Switches (0-3)	<input type="checkbox"/> Exhaust In Fire
<input type="checkbox"/> Qty. Light Switches (0-3)	<input type="checkbox"/> MUA Interface
<input type="checkbox"/> Qty. Temp. Switches (0-1)	<input type="checkbox"/> Lights Out in Fire
<input type="checkbox"/> One Switch for L & F	<input type="checkbox"/> Fire Relay (#1)
<input checked="" type="checkbox"/> Digital Temperature Interlock	<input type="checkbox"/> Extra Fire Relay (#2)
<input type="checkbox"/> Mounted Sensors - Factory	<input type="checkbox"/> Extra Fire Relay (#3)
<input type="checkbox"/> Mounted Sensors - Field	<input type="checkbox"/> DPDT Relay w/SF
<input type="checkbox"/> Heat Switch	<input type="checkbox"/> DPDT Relay w/EF
<input type="checkbox"/> Cool Switch	<input type="checkbox"/> Off Delay Relay
<input type="checkbox"/> AD Switch	<input type="checkbox"/> SF Failure Light
<input type="checkbox"/> Remote Switches	<input type="checkbox"/> EF Failure Light
<input type="checkbox"/> Audible Alarm	<input type="checkbox"/> Fan Failure Light (Appl)
<input type="checkbox"/> Gas Reset	<input type="checkbox"/> Aux. Supply Contact
<input type="checkbox"/> Power for Gas Solenoid	<input type="checkbox"/> Tie in WWCP
<input type="checkbox"/> Power for Shunt Trip	

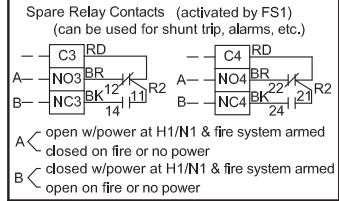
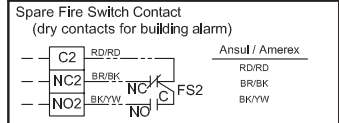

TORQUE:	FIELD WIRING:
TERMINAL BLOCKS = 8 LBJN	USE MINIMUM
GROUNDING BLOCKS = 6 LBJN	60' Copper Wire

LABEL DESCRIPTION	FACTORY WIRING
EF Exhaust Fan	---
SF Supply Fan	---
ST Starter	---
OL OverLoad	ALL WIRING 90°C 14 GA.
C Contactor	UNLESS SPECIFIED
G Ground	
S Switch	
LT Light	
FS Fire Switch	
R Relay	
AF Air Flow Switch	
SV Gas Solenoid	
STB Shunt Trip Breaker	
D Damper	
PB PushButton	
EC Evap Coder	
T Temperature Sensor	
TC Temperature Controller	

NOTES:
Drawing shown de-energized at L1 (term. #H1), w/ Fire System armed (non-fire mode). (normal operation, R1 & R2 are energized) If wall mounted prewire, or field installed fire system, the fire system microswitches must be field wired.

UL LISTED UNDER SUBJECT 891
FILE #E200616

Wiring Diagram #
SAMPLE XFCC W/ TEMP INT



Testing

1. Turn fan switch on, then off to ensure proper fan operation before cooking equipment is started. Once this is verified, testing can proceed.
2. Heat up cooking equipment with fans off. Once the temperature reaches the set point of the temperature controller the fans will start within 5 minutes. If the fans take more than 5 minutes to start, decrease the temperature set point by adjusting the set point on the temperature controller (see Calibration).
3. If an adjustment was made in Step 2, repeat now.
4. After verification of fan start-up, shut down cooking equipment. The fan switch should still be in the off position. Once cooking equipment has cooled below the set point plus hysteresis, the fans will shut down.

CAUTION

The probes should never be exposed to direct flame. The probes are rated up to 250°F.

CAUTION

EXPOSING THE SENSOR TO DIRECT FLAME MAY RENDER THE SENSOR INOPERABLE AND WILL VOID THE WARRANTY.

NOTE

During testing, if fans do not start automatically in the first 10 minutes of cooking equipment activation, manually start fans to avoid accidental fire system dump due to heat build-up.

Operation

1. Turn fans on and off using the fan switch. It is normal for the fans to remain running after the switch is turned off. The exhaust temperature controller will open after heat is no longer present under the hood and the temperature is below the set point plus hysteresis, the fans shall shut down.
2. In the event that the cooking equipment is started without turning the fans on manually, the fans will turn on automatically and remain running with the presence of heat under the hood. Once the temperature is below the set point plus hysteresis, the fans shall shut down.

Troubleshooting

- 1. Controller(s) display E01 or E02 and fans will not shut off.**
 - E01 and E02 represent probe faults
 - Check probe resistance between the two leads when disconnected from the system. At room temperature (77°F), the probe will read 1025 ohms
 - Check wiring connections between the sensor and control cabinet
- 2. Fans do not turn on automatically upon cooking equipment activation.**
 - Check wiring to control panel or relay box
 - Multiple sensors must be wired separately
 - Temperature set point too high, decrease set point
 - No power to fans, check breakers/starters/relays
- 3. Fans do not shut off.**
 - Check the controller to determine if there is a probe error of E01 or E02. If yes, refer to the controller display error message, item 1 above.
 - Switch must be in the off position
 - Cooking equipment hot, wait for it to cool
 - Temperature set point too low, increase set point
 - Ensure wires are connected to appropriate control circuit
- 4. Fans do not turn on quick enough.**
 - Decrease temperature set point

Maintenance

Daily

Clean the temperature sensor with cloth and degreaser. Keep clean for best performance.

Weekly

Dependant on grease production and grease filter type, clean temperature sensor.

Seasonal

May have to change temperature setting on the temperature controller if ambient kitchen temperatures fluctuate between summer and winter seasons.

Whom to call

Contact your local Accurex representative.

What to have ready for the call

Sales order, serial number and description of product.

Sales Order Number _____

Serial Number _____



Frequently Asked Questions

What temperature is the temperature controller set to from the factory?

95° Fahrenheit.

Will the temperature interlock automatically start/stop the fans?

When connected properly to fan starters the temperature interlock will automatically control the fans without input from the user. However, the intended use of the temperature interlock is as back-up to manual control.

May I connect the power going to my fan directly through the control box?

No, the control box should only use control voltage only (24-120V), and a separate 120V power source is required to run the temperature interlock controls. Accurex recommends the use of starters sized for each fan.

Can I use one control box for multiple hood systems?

This can be done, however, it is not recommended. Any one of the temperature controllers would turn on all hoods running on that control box. It is better to have one hood/fan per control box, plus a significant energy savings can be obtained if one or more of the hoods is not in operation.

Can I still turn my fan on and off?

Yes, the temperature interlock is designed to be operated with a typical on/off switch. The fan may not turn off directly after turning the fan switch off, it will sense when the cooking operations have cooled and then turn off.

Replacement Parts

Part Number	Description
384925	Temperature Sensor (RTD) MAMAC TE-700-0-3-A
384920	Temperature Controller CAREL iR33-DN33 DN33W7HR20
830125	Extension, Octagon (drilled) SC55151-1/2 (380928)
732396	J-Box Plate
380926	Cover, Octagon Box SC#54-C-1RACO 722
384905	Terminal Block, Single Pole, DIN-RAIL MT, ABB ZS6
384908	Jumper, DIN-RAIL Terminal Block Two Pole ABB JB6-2
463570	Evergreen Compression Seal 1/4-inch, #302

Codes and Standards Compliance

- UL 710
- National Fire Protection Association (NFPA 96)
- International Mechanical Code (IMC) 2006 Section 507.2.1.1

Our Commitment

As a result of our commitment to continuous improvement, Accurex reserves the right to change specifications without notice.

Specific Accurex product warranties are located on accurex-systems.com within the product area tabs and in the Library under Warranties.



P.O. Box 410 Schofield, WI 54476
Phone: 800.333.1400 Fax: 715.241.6191
www.accurex-systems.com