

## Installation, Operation and Maintenance Manual

Please read and save these instructions for future reference. Read carefully before attempting to assemble, install, operate or maintain the product described. Protect yourself and others by observing all safety information. Failure to comply with instructions will result in voiding of the product warranty and may result in personal injury and/or property damage.

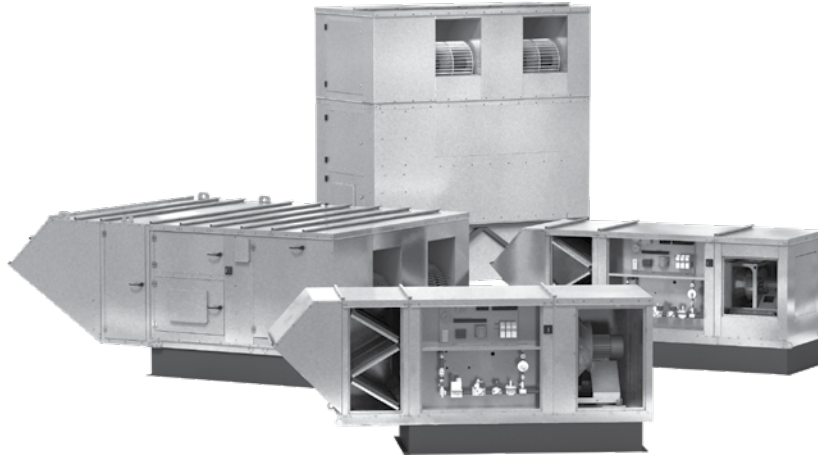

### General Safety Information

#### DANGER

Always disconnect power before working on or near a unit. Use appropriate lockout tagout procedures to prevent accidental power up.

#### CAUTION

When servicing the unit, motor may be hot enough to cause pain or injury. Allow motor to cool before servicing.

#### FOR YOUR SAFETY

If you smell gas:

1. Open windows.
2. Do not touch electrical switches.
3. Extinguish any open flame.
4. Immediately call your gas supplier.

#### FOR YOUR SAFETY

The use and storage of gasoline or other flammable vapors and liquids in open containers in the vicinity of this appliance is hazardous.

#### WARNING

Improper installation, adjustment, alteration, service or maintenance can cause property damage, injury or death. Read the installation, operating and maintenance instructions thoroughly before installing or servicing this equipment.

#### FOR YOUR SAFETY

This appliance is not intended for use by persons (including children) with reduced physical, sensory or mental capabilities, or lack of experience and knowledge, unless they have been given supervision or instruction concerning use of the appliance by a person responsible for their safety. Children should be supervised to ensure that they do not play with the appliance.

#### FOR USE OR APPLICATION

MAXIMUM ALTITUDE: 11154 FT OR 3400 M

## General Safety Information

---

Only qualified personnel should install this unit. Personnel should have a clear understanding of these instructions and should be aware of general safety precautions. Improper installation can result in electric shock, possible injury due to coming in contact with moving parts, as well as other potential hazards. Other considerations may be required if high winds or seismic activity are present. If more information is needed, contact a licensed professional engineer before moving forward.

1. Follow all local electrical and safety codes, as well as the National Electrical Code (NEC), the National Fire Protection Agency (NFPA), where applicable. Follow the Canadian Electrical Code (CEC) in Canada.
2. The rotation of the supply fan wheel is critical. It must be free to rotate without striking or rubbing any stationary objects.
3. Motor must be securely and adequately grounded.
4. Do not spin fan wheel faster than the maximum cataloged fan rpm. Adjustments to fan speed significantly affects motor load. If the fan RPM is changed, the motor current should be checked to make sure it is not exceeding the motor nameplate amps.
5. Do not allow the power cable to kink or come in contact with oil, grease, hot surfaces, or chemicals. Replace cord immediately if damaged.
6. Verify that the power source is compatible with the equipment.
7. Never open fan access doors while the fan is running.



# Table of Contents

## General

Receiving . . . . .	4
Handling . . . . .	4
Unpacking . . . . .	4
Storage	
Indoor . . . . .	4
Outdoor . . . . .	4
Inspection and Maintenance . . . . .	4
Removing from Storage . . . . .	4
Model Number Code . . . . .	5

## Installation

Required Clearances	
Clearance to Combustibles . . . . .	5
Service Clearances . . . . .	6
Duct Sizes . . . . .	7
Indoor Unit Mounting	
Hanging . . . . .	8
Floor Mounted . . . . .	8
Outdoor Unit Mounting	
Standard Curb . . . . .	9
Combination Curb . . . . .	10-11
Slab Mounted . . . . .	12
Rail Mounted . . . . .	12
Optional Component Mounting	
Evaporative Cooling Module . . . . .	13
Diffuser . . . . .	13
Line Voltage Electrical Wiring . . . . .	14
Optional Electrical Accessory Wiring	
Evaporative Cooling Module . . . . .	15
Cooling Relay(s) . . . . .	15
Carbon Dioxide (CO <sub>2</sub> ) Sensor . . . . .	15
Fire Suppression System . . . . .	15
Fire Stat Type III . . . . .	15
Duct Smoke Detector . . . . .	15
Remote Panel . . . . .	15
Room Temperature Sensing Devices . . . . .	16
Piping	
Gas . . . . .	17
Optional Evaporative Cooling Module . . . . .	18-19
Optional Chilled Water Coil . . . . .	20
Optional Components	
Building Pressure Control . . . . .	21
Duct Pressure Control . . . . .	21

## Supply Fan

Fan Identification . . . . .	22
Pre-Start Checks . . . . .	23
Start-Up . . . . .	24

## Pre-Start: Direct Gas-Fired Heating

Ignition Control Identification . . . . .	25
Gas Train Identification . . . . .	25-26
Accessory Identification	
Temperature Control Identification . . . . .	27-28
High/Low Gas Pressure Switch(es) . . . . .	28
UV Scanner . . . . .	28

## Start-Up: Direct Gas-Fired Heating

All Units . . . . .	29-30
120V Pilot System (Honeywell) . . . . .	31
120V Pilot System (Baso) . . . . .	32
24V Commercial Pilot System (=6 inch burner) . . . . .	33
Final Checks . . . . .	34
Optional Features	
Variable Air Volume . . . . .	35-36
Recirculation Operation . . . . .	37
Recirculation Arrangements . . . . .	38

## Start-Up: Optional Features

Evaporative Cooling Module . . . . .	39
Other	
Building Freeze Protection . . . . .	40
Carbon Dioxide (CO <sub>2</sub> ) Sensor . . . . .	40
Duct-Mounted Smoke Detector . . . . .	40
Microprocessor Controls . . . . .	40
PDX Cooling Module . . . . .	40
Dirty Filter Switch . . . . .	40
Heating/Cooling Inlet Air Sensor . . . . .	40
Inlet Damper End Switch . . . . .	40

## Sequence of Operation

Optional Exhaust . . . . .	41
Supply Fan . . . . .	41
Heating . . . . .	41
Optional Cooling . . . . .	42
Optional Variable Air Volume . . . . .	42
Optional Recirculation . . . . .	43
Optional Night Setback . . . . .	44

## Maintenance

### General

V-Belt Drive . . . . .	45
Snow Accumulation . . . . .	45
Supply Wheels . . . . .	45
Bearings . . . . .	45
Motors . . . . .	45
Filters . . . . .	45
Chilled Water Coils . . . . .	45
Evaporative Cooling Module . . . . .	45
Cooling Coils . . . . .	45

### Heating/Cooling

Start-Up . . . . .	47
High Limit . . . . .	47
Burner . . . . .	47
Gas Train . . . . .	47
Evaporative Cooling Module . . . . .	47
Winterizing Chilled Water Coils . . . . .	47

## Troubleshooting

Supply Fan . . . . .	48-59
Direct Gas-Fired Heat . . . . .	50-57
Evaporative Cooling . . . . .	58-59

## Appendix A: Microprocessor Controller

Start-up with Microprocessor Controller . . . . .	60-62
---	-------

## Reference

Control Center Layout . . . . .	63
Start-Up Checklist . . . . .	64
Maintenance Log . . . . .	65-67

Our Commitment . . . . .	Backcover
--------------------------	-----------



## General

### Receiving

This product may have been subject to road salt during transit. If so, immediately wash off all visible white residue from all exterior surfaces. Upon receiving the product, check to ensure all items are accounted for by referencing the delivery receipt or packing list. Inspect each crate or carton for shipping damage before accepting delivery. Alert the carrier if any damage is detected, **do not refuse shipment**. The customer shall make notation of damage (or shortage of items) on the delivery receipt and all copies of the bill of lading should be countersigned by the delivering carrier. If damaged, immediately contact your manufacturer's representative. Any physical damage to the unit after acceptance is not the responsibility of the manufacturer.

### Handling

Units are to be rigged and moved by the lifting brackets provided or by the skid when a forklift is used. Location of brackets varies by model and size. Handle in such a manner as to keep from scratching or chipping the coating. Damaged finish may reduce ability of unit to resist corrosion.

### Unpacking

Verify that all required parts and the correct quantity of each item have been received. Inspect interior of unit cabinet for any shipped loose items. If any items are missing, report shortages to your local representative to arrange for obtaining missing parts. Sometimes it is not possible that all items for the unit be shipped together due to availability of transportation and truck space. Confirmation of shipment(s) must be limited to only items on the bill of lading.

### Storage

Units are protected against damage during shipment. If the unit cannot be installed and operated immediately, precautions need to be taken to prevent deterioration of the unit during storage. The user assumes responsibility of the unit and accessories while in storage. The manufacturer will not be responsible for damage during storage. These suggestions are provided solely as a convenience to the user.

The ideal environment for the storage of units and accessories is indoors, above grade, in a low humidity atmosphere which is sealed to prevent the entry of blowing dust, rain, or snow. Units designed for outdoor applications may be stored outdoors. All accessories must be stored indoors in a clean, dry atmosphere.

### Indoor

Maintain temperatures evenly to prevent condensation. Remove any accumulations of dirt, water, ice, or snow and wipe dry before moving to indoor storage. To avoid condensation, allow cold parts to reach room

temperature. Leave coverings loose to permit air circulation and to allow for periodic inspection.

The unit should be stored at least 3½ in. (89 mm) off the floor. Clearance should be provided to permit air circulation and space for inspection.

### Outdoor

The unit should be placed on a level surface to prevent water from leaking into the unit. The unit should be elevated so that it is above water and snow levels. Ensure sufficient support to prevent unit from settling into soft ground. Locate parts far enough apart to permit air circulation, sunlight, and space for periodic inspection. To minimize water accumulation, place all unit parts on blocking supports so that rain water will run off.

Do not cover parts with plastic film or tarps as these cause condensation of moisture from the air passing through heating and cooling cycles.

### Inspection and Maintenance

While in storage, inspect units once per month. Keep a record of inspection and maintenance performed.

If moisture or dirt accumulations are found on parts, the source should be located and eliminated. At each inspection, rotate the fan wheel by hand ten to fifteen revolutions to distribute lubricant on motor. If paint deterioration begins, consideration should be given to touch-up or repainting. Units with special coatings may require special techniques for touch-up or repair.

Machined parts coated with rust preventive should be restored to good condition promptly if signs of rust occur. Immediately remove the original rust preventive coating with petroleum solvent and clean with lint-free cloths. Polish any remaining rust from surface with crocus cloth or fine emery paper and oil. Do not destroy the continuity of the surfaces. Wipe thoroughly clean with Tectyl® 506 (Ashland Inc.) or the equivalent. For hard to reach internal surfaces or for occasional use, consider using Tectyl® 511M Rust Preventive, WD-40® or the equivalent.

### Removing from Storage

As units are removed from storage to be installed in their final location, they should be protected and maintained in a similar fashion until the equipment goes into operation.

Prior to installing the unit and system components, inspect the unit assembly to make sure it is in working order.

1. Check all fasteners, set screws on the fan, wheel, bearings, drive, motor base, and accessories for tightness.
2. Rotate the fan wheel(s) by hand and assure no parts are rubbing.



## General

### Model Number Code

The model number code provides basic identification of the unit. The serial number can be used by the manufacturer's representative or the factory to identify the specific unit configuration. The serial number of the unit must be provided when consulting the manufacturer's representative or the factory.

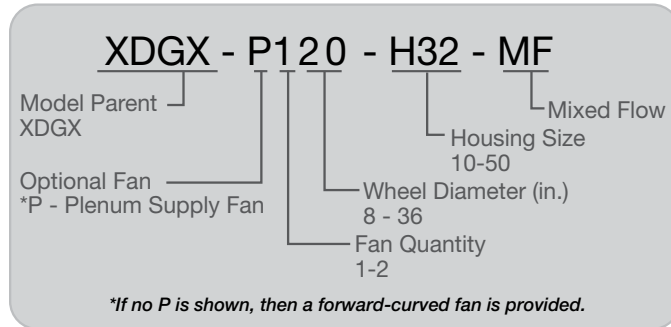

RANGE OF EXTERNAL STATIC PRESSURES: 0.00 - 4.00 IN.W.C. OR 0.000 - 0.995 KPA

## Installation

### Required Clearances

#### Clearance to Combustibles

Clearance to combustibles is defined as the minimum distance required between the unit and adjacent combustible surfaces to ensure the adjacent surface temperature does not exceed 90°F above the ambient temperature.

	Floor	Top	Sides	Ends
Insulated/Units	0	0	0	0
Non Insulated Units	0	6 (16)	6 (16)	6 (16)

All measurements are shown in inches (cm).

# Installation

## Required Clearances

### Service Clearances

Service clearances are factory recommendations for ease of servicing. All deviations must still adhere to clearance to combustibles requirements. All deviations from the service clearance recommendations are at the discretion of the end-user as this may impede component removal.

Reference the *Start-Up: Optional Features, Other, PDX Cooling Module* section in this Installation, Operation and Maintenance Manual for further clearance requirements, if applicable.

Not all models listed will incorporate access on both sides; this will vary based on supply fan type and options selected.

Note: If XDGX-H05 is equipped with an evaporative cooling module, access to the filters, media, sump, and water connections is accomplished through the roof of the evaporative cooling module. A minimum service clearance of 24 inches (61 cm) is recommended above this module.

Recommended Minimum Service Clearances		
Model	Housing	A inches (cm)
XDGX	H12	33 (84)
	H22	44 (112)**
	H32	52 (132)
	H35	78 (198)
	H38	96 (244)
	H42	101 (255)

\* 67 in. (170 cm) when equipped with evaporative cooling module

\*\* 61 in. (155 cm) when equipped with evaporative cooling module over 4800 cfm

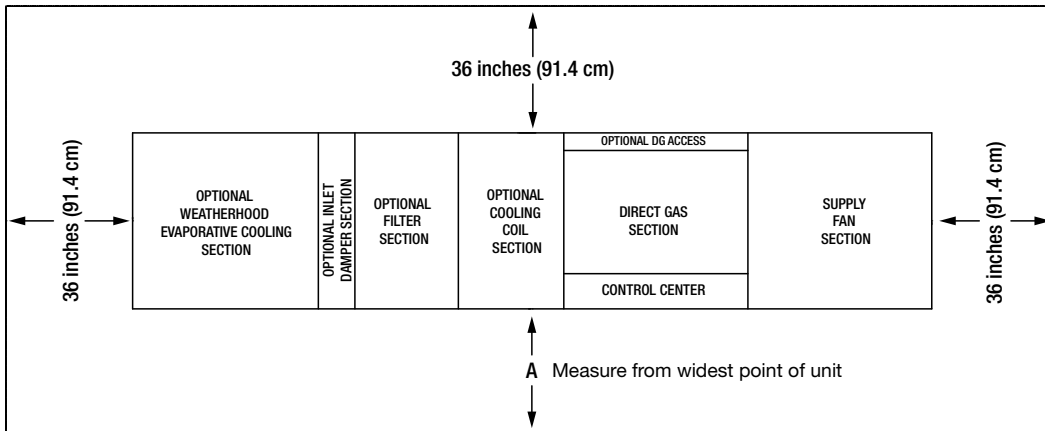

# Installation

## Duct Sizes

See charts for duct sizes and straight duct lengths recommended for optimal performance based on AMCA Publication 201-90. Using duct sizes less than recommended will affect fan performance. Follow good duct installation practices for the remaining ductwork.

Forward Curved Fans (Horizontal Units)				
Model	Fan	H	W	Straight Duct Length
XDGX	108	13 (33)	10 (25)	32 (81)
	109	13 (33)	14 (36)	38 (97)
	110	14 (36)	16 (41)	42 (107)
	112	16 (41)	18 (46)	48 (122)
	115	18 (46)	22 (56)	56 (142)
	118	22 (56)	24 (61)	65 (165)
	120	28 (71)	26 (66)	76 (193)
	122	30 (76)	30 (76)	85 (216)
	125	34 (86)	34 (86)	96 (244)
	127	38 (97)	38 (97)	107 (272)
	130	40 (102)	40 (102)	113 (287)
	133	46 (117)	42 (107)	124 (314)
	136	46 (117)	46 (117)	130 (330)

All measurements are shown in inches (cm).

Plenum Fans										
Model	Housing	Down Discharge			End Discharge			Side Discharge		
		H	W	Straight Duct Length	H	W	Straight Duct Length	H	W	Straight Duct Length
XDGX	H05	15.8 (40)	15 (38)	43 (110)	20 (51)	19.5 (50)	56 (142)	20 (51)	19.5 (50)	56 (142)
	H12	22.5 (57)	22.5 (57)	63 (160)	22.5 (57)	22.5 (57)	63 (160)	22.5 (57)	22.5 (57)	63 (160)
	H12-D1	18.5 (47)	22.5 (57)	55 (140)	30.9 (79)	28.1 (71)	83 (211)	32.3 (82)	20.5 (52)	83 (211)
	H12-MF	16.8 (42.6)	22.8 (58)	55 (140)	31 (79)	28.2 (72)	83 (211)	26.1 (66)	32.8 (83)	83 (211)
	H22	25.5 (65)	25.5 (65)	72 (183)	25.5 (65)	25.5 (65)	72 (183)	25.5 (65)	25.5 (65)	72 (183)
	H22-D1	22.5 (57)	32.5 (83)	86 (218)	37 (94)	39 (99)	107 (272)	38 (97)	24.3 (62)	89 (226)
	H22-MF	27.5 (70)	33.6 (85)	86 (218)	36.8 (94)	39.1 (99)	107 (272)	38.7 (98)	25.5 (65)	89 (226)
	H32	31.5 (80)	31.5 (80)	89 (226)	31.5 (80)	31.5 (80)	89 (226)	31.5 (80)	31.5 (80)	89 (226)
	H32-D1/D3	28.5 (72)	41.5 (105)	105 (267)	39.8 (101)	47 (119)	122 (310)	41.8 (106)	35.4 (90)	103 (261)
	H32-MF	32.9 (84)	42 (107)	105 (267)	39.8 (101)	46.9 (119)	122 (310)	42.1 (107)	31.5 (80)	103 (261)
	H35	30 (76)	62 (157)	121 (307)	30 (76)	61.2 (155)	121 (307)	35 (89)	33 (84)	96 (244)
	H38	36 (91)	72 (183)	143 (363)	35.8 (91)	72 (183)	143 (363)	40 (102)	36 (91)	107 (271)
	H42	40 (102)	78 (198)	157 (399)	40 (102)	77.5 (197)	157 (399)	40 (102)	40 (102)	113 (287)

All measurements are shown in inches (cm).

# Installation

## Indoor Unit Mounting

### Hanging

When suspending a unit indoors, adequate structural support is required. Design of the support structure is the responsibility of the installing contractor and/or the structural engineer. Support structure will vary based on application, building design, code requirements, unit size, and unit weight. The following information is provided as a guideline; it is not intended to replace job specific structural design provided by a structural engineer.

#### 1. Install Field-Supplied Hangers

Install hangers from ceiling supports. Ensure hangers are located to avoid interference with access doors and allows for component removal.

#### 2. Install Unit

Using sheet metal screws, assemble optional shipped loose modules. Ensure that all cover seams and vertical panels on each module are fastened securely. Raise the assembled unit into place.

Appropriate field-supplied unit supports, such as C-channel or angle iron, are to be placed under the unit. Fasten the unit supports to the hangers and to the unit using appropriate methods.

To prevent the unit from swinging and to provide a safe environment for service and maintenance, additional measures must be taken to secure the unit in all directions.

The installer is responsible for determining appropriate support and fastening methods to ensure compliance with all applicable codes.

#### 3. Attach Ductwork

Using appropriate methods, attach ductwork to unit. Follow good duct practices for all ductwork. Install ductwork in accordance with SMACNA and AMCA guidelines, NFPA 96 and any further local codes. Reference *Installation, Duct Sizes* section in this Installation, Operation, and Maintenance Manual for proper duct sizes.

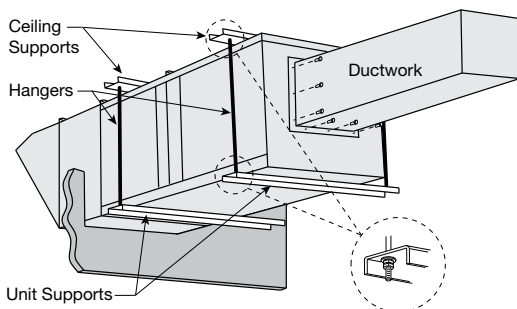

#### 4. Seal Wall Opening

Sealant must be applied around the perimeter of the weatherhood to prevent water penetration and drafts into the building.

### Floor Mounted

#### 1. Install Unit

Use a crane and a set of spreader bars hooked to the factory lifting lugs to lift and locate the unit in place. The use of all lifting lugs and a set of spreader bars is mandatory when lifting the unit.

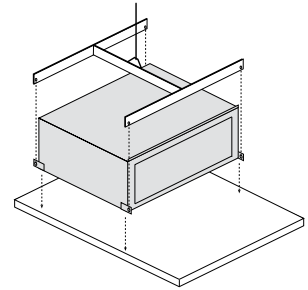

It is recommended that any shipped loose modules be installed after the base unit. The shipped loose modules must be fastened together. Fasten the cover seams and vertical panels on each module using sheet metal screws. Some shipped loose modules will require field-provided shims for proper alignment with the base unit.

Fasten the unit using appropriate methods. The installer is responsible for determining appropriate support and fastening methods to ensure compliance with all applicable codes.

#### 2. Attach Ductwork

Refer to the unit submittal for the duct size and location. An appropriate sealant should be used around the discharge opening of the unit to create a weathertight seal.

Follow good duct practices for all ductwork. Install ductwork in accordance with SMACNA and AMCA guidelines, NFPA 96 and local codes. Reference *Installation, Duct Sizes* section in this Installation, Operation, and Maintenance Manual for proper duct sizes.

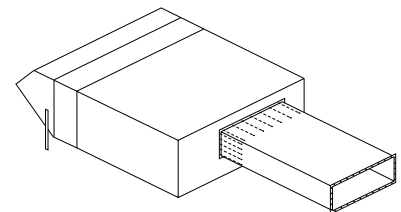

#### Note for both Hanging and Floor Mounted Installations:

The manufacturer recommends units equipped with evaporative cooling be installed outdoors. If an evaporative cooling module must be installed indoors, it is recommended a field-supplied secondary drain pan be installed under the evaporative cooling section. This will help mitigate damage to building materials in the event the evaporative cooling module sump tank overflows.





# Installation

## Outdoor Unit Mounting

### Standard Curb

#### 1. Install Curb and/or Equipment/Leg Support(s)

Position curb and/or equipment/leg support(s) on the roof (reference the unit submittal for placement in relation to the unit). Verify that unit supports are level; shim if necessary. Attach curb to roof and flash into place using appropriate methods. Attach the equipment/leg support(s) to the roof, remove metal cover, flash to wooden nailer, and reinstall cover.

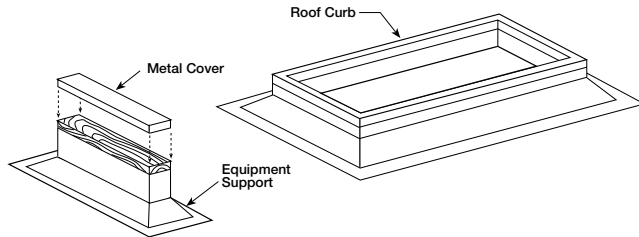

Curb and Equipment Support

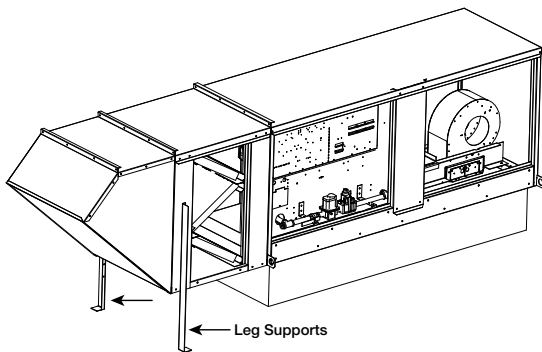

Unit Profile and Leg Support

#### 2. Install Ductwork

Follow good duct practices for all ductwork. Install ductwork in accordance with SMACNA and AMCA guidelines, NFPA 96 and local codes. Reference *Installation, Duct Sizes* section in this Installation, Operation, and Maintenance Manual for proper duct sizes.

The use of a duct adapter is recommended on a downblast (DB) arrangement to align the ductwork with the supply unit. The duct adapter is only a guide and is not to be used as a support for the ductwork.

#### 3. Apply Sealant

Apply an appropriate sealant around the perimeter of the curb and duct to isolate fan vibration and prevent water penetration.

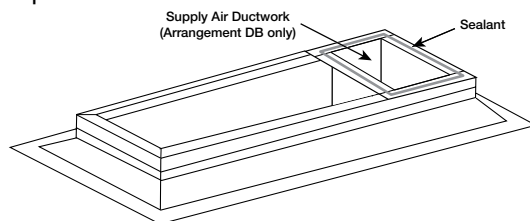

Ductwork

#### 4. Install Unit

Use a crane and a set of spreader bars hooked to the factory lifting lugs to lift and position the unit on the curb/equipment support(s). The use of all lifting lugs and a set of spreader bars is mandatory when lifting the unit. Fasten the unit to the curb/equipment support(s) using appropriate methods. The installer is responsible for determining appropriate support and fastening methods to ensure compliance with all applicable codes.

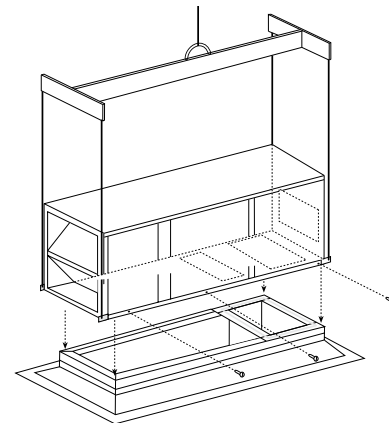

Setting Unit

#### 5. Assemble and Attach Shipped Loose Modules

Using sheet metal screws, assemble optional shipped loose modules. Fasten the cover seams and vertical panels on each module securely.

Some weatherhoods may ship disassembled. Detailed assembly instructions ship with the weatherhood.

If an optional evaporative cooling module is included, reference *Installation, Optional Component Mounting, Evaporative Cooling Module* section in this Installation, Operation and Maintenance Manual for more information.

The installer is responsible for ensuring that the unit fastening methods are sufficient to account for the weight and size of these additional modules.

#### 6. Seal Seam(s)

Using an appropriate sealant, seal the seam(s) between each shipped loose module and the weatherhood.

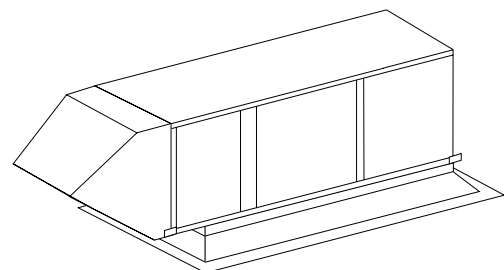

Complete Rooftop Installation

### Combination Curb

#### 1. Install Curb and Equipment/Leg Support(s)

Position curb and equipment/leg support(s) on the roof (reference the unit submittal for placement in relation to the unit). Verify that unit supports are level, shim if necessary. Attach curb to roof and flash into place using appropriate methods. Attach the equipment/leg support(s) to the roof, remove metal cover, flash to wooden nailer and reinstall cover.

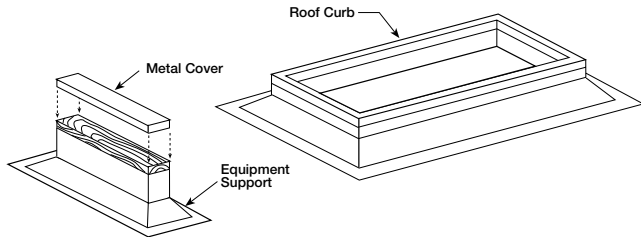

**Curb and Equipment Support**

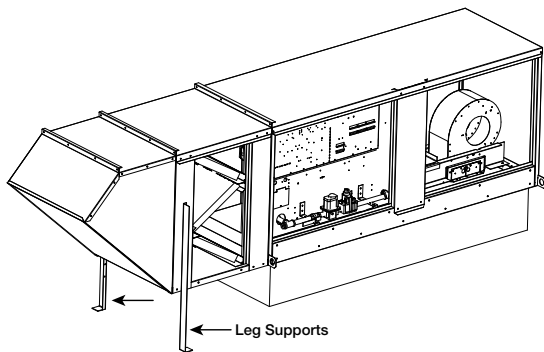

**Unit Profile and Leg Support**

#### 2. Install Combination Curb Adaptor

Install combination curb adaptor over curb, fasten adaptor to curb using appropriate methods. Locate extension so the tall louvered side is over the exhaust opening, as shown in illustration. Caulk vented exhaust extension to combination curb adaptor. Fasten extension to curb adaptor using appropriate methods (field-provided).

The installer is responsible for determining appropriate support and fastening methods to ensure compliance with all applicable codes.

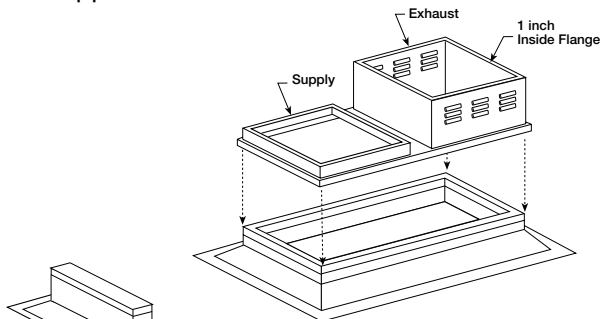

**Combination Extension**

#### 3. Install Ductwork

Follow good duct practices for all ductwork. Install ductwork in accordance with SMACNA and AMCA guidelines, NFPA 96 and local codes. Reference *Installation, Duct Sizes* section in this Installation, Operation, and Maintenance Manual for proper duct sizes.

The use of a duct adapter is recommended on a downblast (DB) arrangement to align the ductwork with the supply unit. The duct adapter is only a guide and is not to be used as a support for the ductwork.

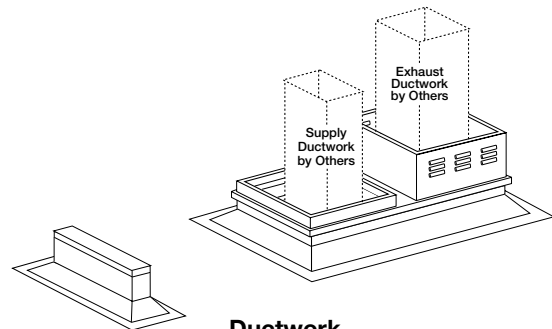

**Ductwork**

#### 4. Apply Sealant

Apply an appropriate sealant around the perimeter of the curb and duct to isolate unit vibration and prevent water penetration.

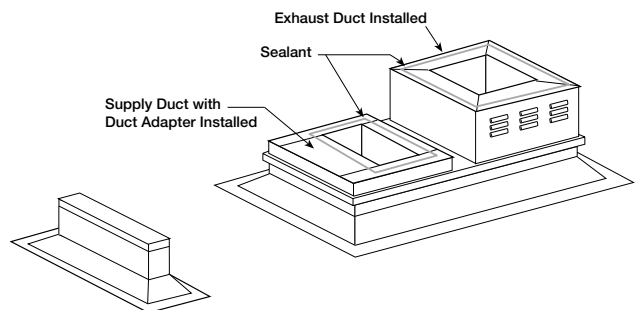

**Sealing Ductwork**



# Installation

## Outdoor Unit Mounting

### Combination Curb (continued)

#### 5. Install Exhaust Fan

Fasten exhaust fan to curb extension using appropriate methods. Installing the exhaust fan prior to the supply unit will allow for easier installation of options. NFPA 96 requires the exhaust fan to be hinged. Follow instructions included with the exhaust fan.

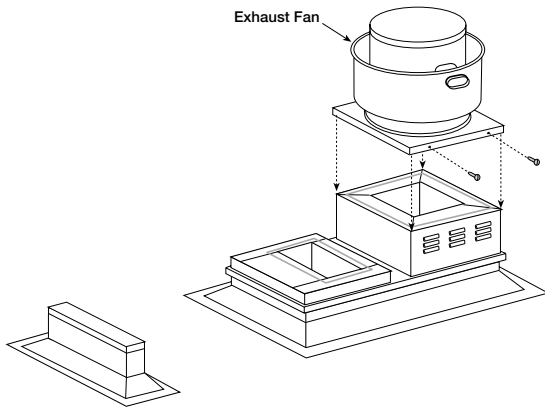

Installing Exhaust Fan

#### 6. Install Exhaust Fan Options

Install hinges (an optional hinge kit is available from manufacturer) with restraining cables and optional grease trap with drain connection.

#### 7. Install Supply Unit

Use a crane and a set of spreader bars hooked to the factory lifting lugs to lift and position the unit on the curb extension and equipment support(s). The use of all lifting lugs and a set of spreader bars is mandatory when lifting unit.

Fasten the unit to the curb extension and equipment support(s) using appropriate methods. The installer is responsible for determining appropriate support and fastening methods to ensure compliance with all applicable codes.

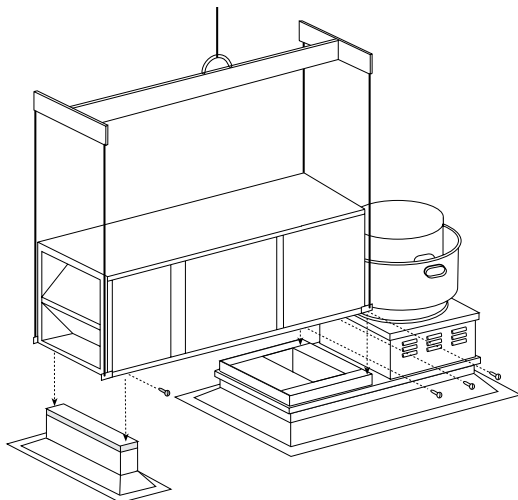

Installing Supply Unit

#### 8. Assemble and Attach Shipped loose Modules

Using sheet metal screws, assemble optional shipped loose modules. Fasten the cover seams and vertical panels on each module securely.

Some weatherhoods may ship disassembled. Detailed assembly instructions ship with the weatherhood.

If an optional evaporative cooling module is included, reference *Installation, Optional Component Mounting, Evaporative Cooling Module* section in this Installation, Operation and Maintenance Manual for more information.

The installer is responsible for ensuring that the unit fastening methods are sufficient to account for the weight and size of these additional modules.

#### 9. Seal Seam(s)

Using an appropriate sealant, seal the seam(s) between each shipped loose module and weatherhood.

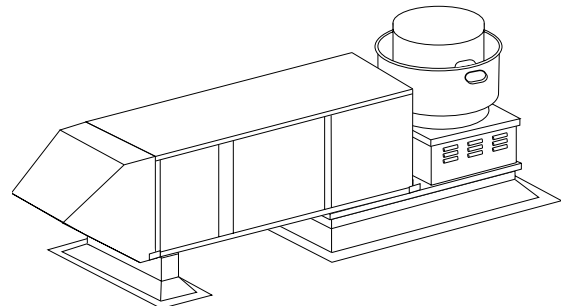

Complete Combination Installation

# Installation

## Outdoor Unit Mounting

### Slab

#### 1. Pour Concrete Slab

Pour the concrete slab. Make the slab one foot larger than the unit on all sides. The slab must be capable of supporting the weight of the unit. Proper subgrade preparation must be completed under the slab. Allow the concrete slab to properly cure before installing the unit.

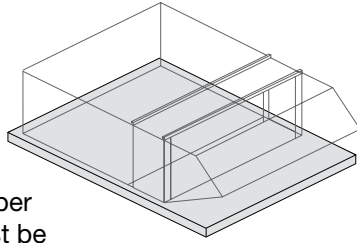

#### 2. Install Unit

Use a crane and a set of spreader bars hooked to the factory lifting lugs to lift and position the unit on the concrete slab. The use of all lifting lugs and a set of spreader bars is mandatory when lifting the unit. It is recommended that any shipped loose modules be installed after the base unit.

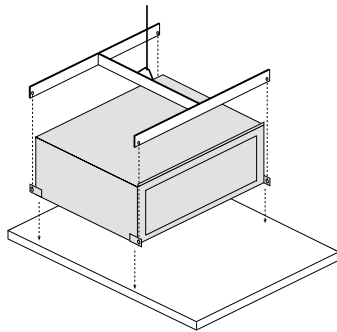

The shipped loose modules must be fastened together. Fasten the cover seams and vertical panels on each module using sheet metal screws. Using an appropriate sealant, seal the seam(s) between each shipped loose module and the weatherhood.

Some shipped loose modules will require field-provided shims for proper alignment with the base unit.

If an optional evaporative cooling module is included, reference *Installation, Optional Component Mounting, Evaporative Cooling Module* section in this Installation, Operation and Maintenance Manual for more information.

Fasten the unit to the slab using appropriate methods. The installer is responsible for determining appropriate fastening methods to ensure compliance with all applicable codes.

#### 3. Attach Ductwork

Use an appropriate sealant around the discharge opening of the unit to create a weathertight seal.

Follow good duct practices for all ductwork. Install ductwork in accordance with SMACNA and AMCA guidelines, NFPA 96 and local codes. Reference *Installation, Duct Sizes* section in this Installation, Operation, and Maintenance Manual for proper duct sizes.

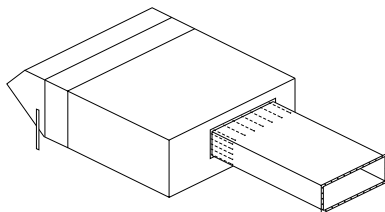

### Rail

#### 1. Install Rails

The rails must be located around the perimeter of the base unit on all four sides. This is required to ensure proper unit support. Model TSU requires an additional rail section under the filter section to ensure proper support of the filter section and weatherhood. Rails are field-supplied by others and are not supplied by manufacturer.

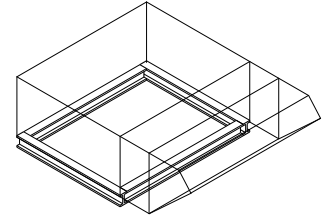

#### 2. Install Unit

Use a crane and a set of spreader bars hooked to the factory lifting lugs to lift and position the unit on the field-supplied rail supports. The use of all lifting lugs and a set of spreader bars is mandatory when lifting the unit. It is recommended that any shipped loose modules be installed after the base unit.

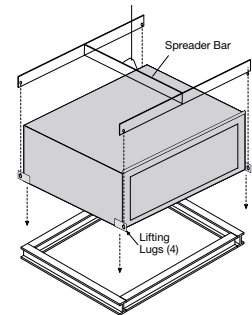

The shipped loose modules must be fastened together. Fasten the cover seams and vertical panels on each module using the appropriate methods. Fasten the unit to the rails using appropriate methods.

If an optional evaporative cooling module is included, reference *Installation, Optional Component Mounting, Evaporative Cooling Module* section in this Installation, Operation and Maintenance Manual for more information.

The installer is responsible for determining appropriate fastening methods to ensure compliance with all applicable codes.

#### 3. Attach Ductwork

Use an appropriate sealant around the discharge opening of the unit to create a weathertight seal.

Follow good duct practices for all ductwork. Install ductwork in accordance with SMACNA and AMCA guidelines, NFPA 96 and local codes. Reference *Installation, Duct Sizes* section in this Installation, Operation, and Maintenance Manual for proper duct sizes.



# Installation

## Optional Component Mounting

### Evaporative Cooling Module

Note: Small evaporative cooling module will ship attached to the base unit from the factory and will not require any additional fixation to the base unit as illustrated below.

#### 1. Locate Equipment Support(s)

Position equipment support(s) on the roof (reference the unit submittal for placement of equipment support(s) in relation to the unit). Verify that all unit supports are level, shim if necessary. Attach equipment support to the roof using appropriate methods, remove metal cover, flash to wooden nailer and reinstall cover.

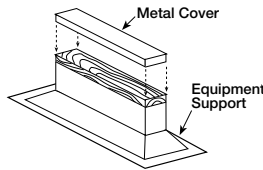

Equipment Support

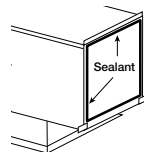

Sealant

#### 2. Apply Sealant

Apply an appropriate sealant around the airstream opening to create an airtight seal.

#### 3. Set Evaporative Cooling Module

Use a crane and a set of spreader bars hooked to the factory lifting lugs to lift and position the module on the equipment support(s). The cover flange on the evaporative cooling module should overlap the cover flange on the unit. The use of all lifting lugs and a set of spreader bars is mandatory when lifting the evaporative cooling module.

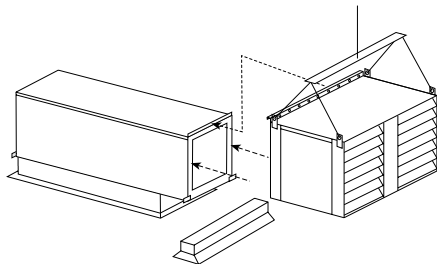

Placing Evaporative Module

#### 4. Secure Cooling Module to Unit

Use self-tapping screws to fasten the cooling module to the base unit along the top and down both sides. Fasten at the top through the cover flanges. To fasten the sides, the media may need to be removed. To remove the media, first remove the access panel on the evaporative module and disconnect the evaporative pump(s). The media will now slide out. With the media removed, you can access the side fastening points inside the evaporative cooling module. With all the screws in place, reinstall the media, reconnect the pumps and reinstall the access panel.

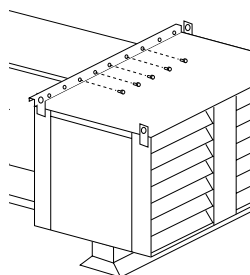

Securing Evaporative Module

The evaporative cooling module must be mounted level to ensure proper operation and water drainage.

### Diffuser

The location of the discharge diffuser is critical for optimum performance of the system.

Using self-tapping screws, attach diffuser to the ductwork or unit. Be sure to maintain the recommended floor to diffuser height. Refer to the chart for this information.

Airflow cfm (m <sup>3</sup> /s)	Diffuser Height feet (m)		
	Minimum	Recommended	Maximum
4,000 (2)	15 (5)	20 (6)	25 (8)
6,000 (3)	15 (5)	20 (6)	25 (8)
8,000 (4)	20 (6)	20-25 (6 - 8)	30 (9)
10,000 (5)	20 (6)	20-25 (6 - 8)	35 (11)
13,000 or greater (6 or greater)	25 (8)	30-35 (9 - 11)	40 (12)

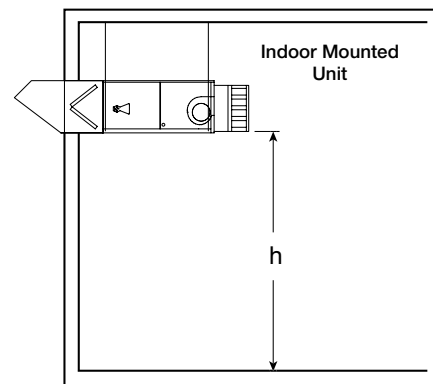

Thru-Wall Diffuser Height

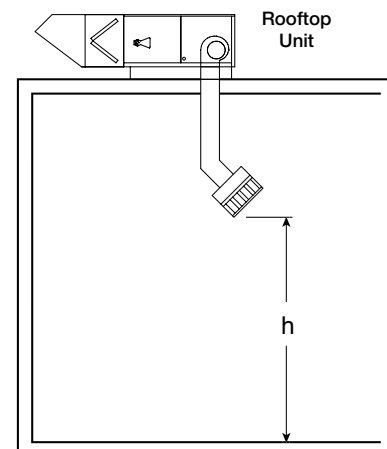

Rooftop Diffuser Height

# Installation

## Line Voltage Electrical Wiring

Before connecting power to the unit, read and understand the following instructions and wiring diagrams. Complete wiring diagrams are attached on the inside of the control center door(s).

All wiring must be done in accordance with the latest edition of the National Electrical Code NFPA 70 and any local codes that may apply. In Canada, wiring must be done in accordance with the Canadian Electrical Code.

The equipment must be properly grounded. Any wiring running through the unit in the airstream must be protected by metal conduit, metal clad cable or raceways.

### WARNING

**RISK OF ELECTRIC SHOCK. CAN CAUSE INJURY OR DEATH:** System contains oversize protective earthing (grounding) terminal which shall be properly connected.

### CAUTION

If replacement wire is required, it must have a temperature rating of at least 105°C.

Any wiring deviations may result in personal injury or property damage. Manufacturer is not responsible for any damage to, or failure of the unit caused by incorrect field wiring.

### DANGER

High voltage electrical input is needed for this equipment. This work should be performed by a qualified electrician.

Manufacturer's standard control voltage is 24 VAC. Control wire resistance must not exceed 0.75 ohms (approximately 285 feet total (86.9 m) length for 14 gauge wire; 455 feet (138.7 m) total length for 12 gauge wire). If the resistance exceeds 0.75 ohms, an industrial-style relay must be wired in place of the remote switch. The relay must be rated for at least 5 amps and have a 24 VAC coil. Failure to comply with these guidelines may cause motor starters to chatter or not pull in, resulting in contactor failures and/or motor failures.

### 1. Determine the Size of the Main Power Lines

The unit's nameplate states the voltage and the unit's MCA. The main power lines to the unit must be sized accordingly. The nameplate is located on the outside of the unit on the control panel side.

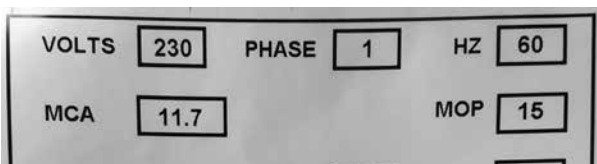

Electrical Nameplate

### 2. Provide the Opening(s) for the Electrical Connections

Electrical openings vary by unit size and arrangement and are field-supplied.

### 3. Connect the Main Power

Connect the main power lines to the disconnect switch and main grounding lug(s). Torque connections to disconnect according manufacturer specifications.

### 4. Wire the Optional Convenience Outlet

The convenience outlet requires a separate 115V power supply circuit. The circuit must include short circuit protection supplied by others.

### 5. Wire Evaporative Cooling Pumps

Reference the unit wiring diagram attached to the inside of the unit control center door. Locate the "Evap Pump(s)" on the wiring diagram. If they are connected with solid lines indicating factory wiring, no field wiring is required.

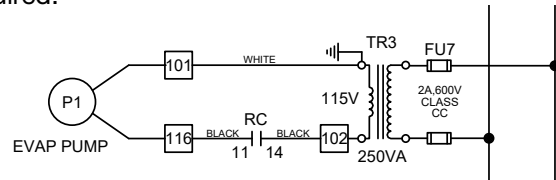

Evap Pump Factory Wiring Example

Refer to wiring diagram for unit specific wiring

If the evaporative pump(s) are shown with dashed lines indicating field wiring, wire the pumps to the terminals indicated in the unit control center.

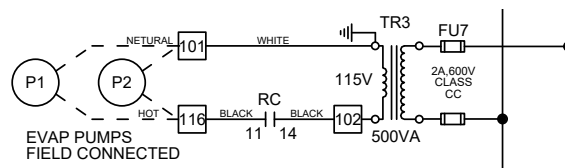

Evap Pump Field Wiring Example

Refer to wiring diagram for unit specific wiring

Larger units may require a separate 115 VAC power source. If this is necessary, it will be indicated on the wiring diagram. Wire a separate 115 VAC power supply as indicated on the wiring diagram to power the pumps.

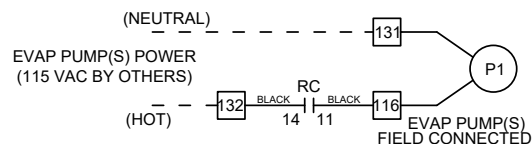

Separate Power Wiring Example

Refer to wiring diagram for unit specific wiring



## Optional Electrical Accessory Wiring

### Evaporative Cooling Module

#### 1. Auto Drain and Fill Valves

The unit may have been provided with the auto drain and fill option. If this option has been provided, the unit wiring diagram will indicate field wiring (dashed lines) to the supply valve, drain valve, and supply drain valve. Wire the valves as indicated on the unit wiring diagram.

Note: The valves can be provided by the factory or field-supplied by others. If field-supplied valves are utilized, the total inrush VA shall not exceed 160 VA and the total holding VA shall not exceed 66 VA with a 24 VAC supply.

#### 2. Freeze Protection Sensor

If the unit was provided with the auto drain and fill option and the evaporative cooling module was shipped separately, the freeze protection sensor must be field-wired. The freeze protection sensor will be factory installed to the bottom side of the top louver on the unit intake. Wire the freeze sensor as indicated on the unit wiring diagram (dashed lines).

#### 3. Single Pass Water Control Valves

The unit may have been provided with the single pass control valve option. If this option has been provided, the unit wiring diagram will indicate field wiring (dashed lines) to the supply valve and supply drain valve. Wire the valves as indicated on the unit wiring diagram.

NOTE: The valves can be provided by the factory or field-supplied by others. If field-supplied valves are utilized, the total inrush VA shall not exceed 160 VA and the total holding VA shall not exceed 66 VA with a 24 VAC supply.

### Cooling Relay(s)

If the unit was provided with an optional chilled water coil the cooling relay can provide an enable signal for the cooling system. When a call for cooling has been signaled, the cooling relay closes a dry NO contact rated for 8 amps and 250 VAC.

### Carbon Dioxide (CO<sub>2</sub>) Sensor

Depending on the application, recirculating units may have been provided with a wall mounted CO<sub>2</sub> sensor. The CO<sub>2</sub> sensor is intended to prevent the build-up of CO<sub>2</sub> in the space. It must be wired as indicated on the unit wiring diagram to command the unit to 100% outside air in the event CO<sub>2</sub> rises above the alarm setting. If a microprocessor is included with this unit, reference the supplemental *Microprocessor Controller for Make-Up Air Reference Guide* for more information.

### Fire Suppression System

The building fire suppression system is typically wired to shut down the unit in the event of a fire. A normally closed (NC) contact should be wired in series with unit enable switch or contact. This is located between terminals R and G on the wiring diagram. When the fire suppression system alarms, it shall open this contact removing 24 VAC power from terminal G which will disable the unit.

### Fire Stat Type III

The optional fire stat type III is shipped separately for field installation and wiring. The fire stat is typically installed in the return air duct to shut down the fan in the event of elevated temperature in the duct. The normally closed (NC) contact can be wired in series with the fire suppression contact to shut down the unit. The fire stat has additional contacts that can be used to alert an external system.

### Duct Smoke Detector

The optional duct smoke detector is shipped separately for field installation and wiring. The smoke detector is typically installed in the return air duct to shut down the fan in the event of a fire. The normally closed (NC) contact should be wired in series with the fire suppression contact to shut down the unit. The smoke detector has additional contacts that can be used to alert an external system.

### Remote Panel

The optional remote panel is shipped separately for field installation and wiring. 24 VAC control wiring must be connected between the remote panel and the unit control center. This wiring is connected point-to-point from the remote panel terminal strip to the unit terminal strip. Refer to the remote panel wiring diagram for details.

Note: Any sensor(s) or temperature adjustment dial(s) on the remote panel must be run with shielded cable or in separate conduit.

# Installation

## Optional Electrical Accessory Wiring

### Room Temperature Sensing Devices

One of the following sensors or equivalent may have been provided and will require field wiring. Refer to the unit wiring diagram for terminal designations. If a microprocessor is included with this unit, reference the supplemental *Microprocessor Controller for Make-Up Air Reference Guide* for more information.

#### Room Override Thermostat

Requires wiring to be run in separate conduit or run with shielded cable.



#### Maxitrol Room Temperature Sensor

Requires wiring to be run in separate conduit or run with shielded cable.



#### Room Thermostat

Requires wiring to be run in separate conduit or run with shielded cable.



#### Unit Controller Room Temperature Sensor

Requires wiring to be run in separate conduit or run with shielded cable.



#### Night Setback Thermostat (occupied/unoccupied mode)





# Installation

## Piping

### Gas

All gas piping must be installed in accordance with the latest edition of the National Fuel Gas Code ANSI/Z223.1 and any local codes that may apply. In Canada, the equipment shall be installed in accordance with the Installation Code for Gas Burning Appliances and Equipment (CGA B149) and Provincial Regulations for the class. Consult authorities having jurisdiction before installations are made. All piping must be clean and free of any foreign matter. Foreign material entering the gas train can damage the valves, regulators and burner.

Do not connect the unit to gas types other than what is specified and do not connect the unit to gas pressures that are outside of the pressure range shown on the label.

When connecting the gas supply, the length of the run must be considered in determining the pipe size to avoid excessive pressure drop. Refer to a Gas Engineer's Handbook for gas pipe capacities.

### WARNING

All components of this or any other gas-fired heating unit must be leak tested prior to placing the unit into operation. Use a soap and water solution or equivalent to perform this test. NEVER test for gas leaks with an open flame.

When leak testing pressures that are equal to 14 in. wg (3.5 kPa), first close the field-installed shutoff valve to isolate the unit from the gas supply line.

When leak testing pressures that are above 14 in. wg (3.5 kPa), close the field-installed shutoff valve, disconnect the furnace and gas train from the gas supply line, and plug the supply line before testing.

### 1. Determine the Supply Gas Requirements

The unit's direct gas nameplate states the requirements for the gas being supplied to the unit. The direct gas nameplate is located on the outside of the unit on the control center side.

Minimum gas pressure for design temperature rise

MAX. BTU/HR. BTU/HR. MAX.	464,000	MIN. BTU/HR. BTU/HR. MIN.	32,000
NORMAL MANIFOLD PRESSURE PRESSION D'ADMISSION NORMALE	5 "W.C.	MIN. GAS PRESSURE FOR MAX. OUTPUT PRESSION DE GAZ MIN. POUR PUISSANCE MAX.	10 "W.C.
MIN. GAS PRESSURE PRESSION DE GAZ	6 "W.C.	MAX. GAS PRESSURE PRESSION DE GAZ MAX.	0.5 PSI
MIN. BURNER PRESSURE DROP PERTE MIN. DE PRESSION DANS LE BRULEUR	0.2 "W.C.	MAX. BURNER PRESSURE DROP PERTE MAX. DE PRESSION DANS LE BRULEUR	1.2 "W.C.
TYPE OF GAS NATURE DU GAZ	NATURAL	DESIGN TEMP. CHANGE DESIGN TEMP. NORMALE	85
EQUIPPED FOR CONCU POUR	5,650 SCFM CONTE	AGAINST CONTRE	.25 "W.C. EXTERNAL STATIC PRESSURE PRESSION STATIQUE EXTERIEURE

START UP INSTRUCTIONS  
1. SET THE THERMOSTAT TO THE DESIRED SETTING.  
2. ENERGIZE THE HEATER.  
IF THE FLAME DOES NOT LIGHT WITHIN 1 MINUTE, CHECK THE TROUBLE SHOOTING SECTION IN THE INSTALLATION OPERATION

Direct Gas Nameplate

### 2. Install Additional Regulator if Required

When the supply gas pressure exceeds the maximum gas pressure shown on the direct gas nameplate, an additional regulator is required to reduce the pressure. The regulator must be a full lock up type. Additionally, it must incorporate a listed leak limiting device or be vented to the outdoors.

### 3. Connect the Supply Gas Line

A manual shut off valve, 1/8 in. plugged test port and 6 in. drip leg must be installed prior to the gas train. The valve and the test port must be accessible for the connection of a test gauge. Supply gas connections must be made by a qualified installer and are not furnished by manufacturer.

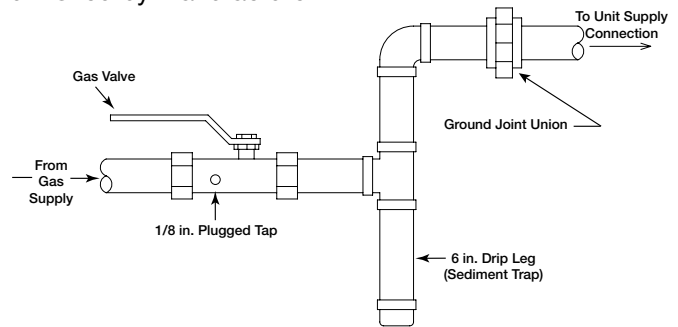

Supply Gas Line

### 4. Test the System for Leaks

### WARNING

NEVER test for a gas leak with an open flame.

Check both the supply lines and the factory piping for leaks. Apply a soap and water solution or equivalent to all piping and watch for bubbling which indicates a leak.

The factory piping has been checked for leaks, but must be rechecked due to possible movement during shipping and installation.

# Installation

## Piping

### Optional Evaporative Cooling Module

#### Recirculating Pump

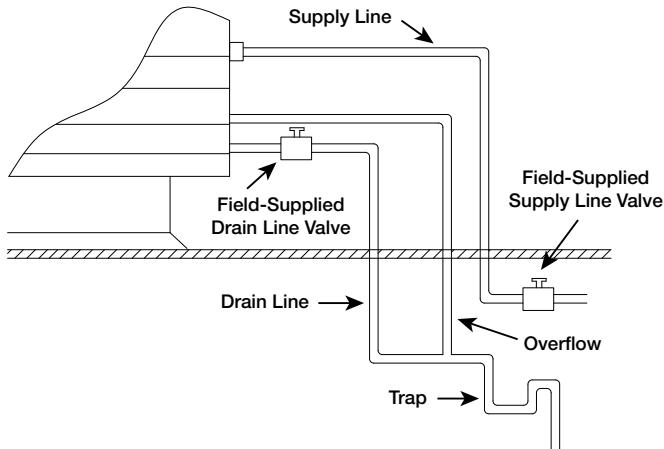

#### Single Pass

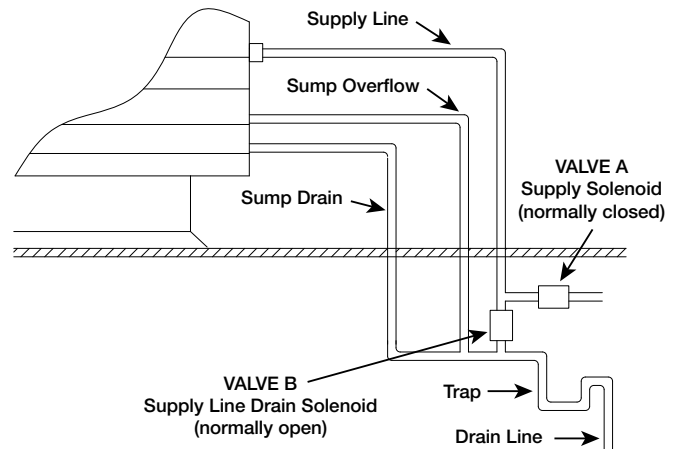

#### Auto Drain and Fill

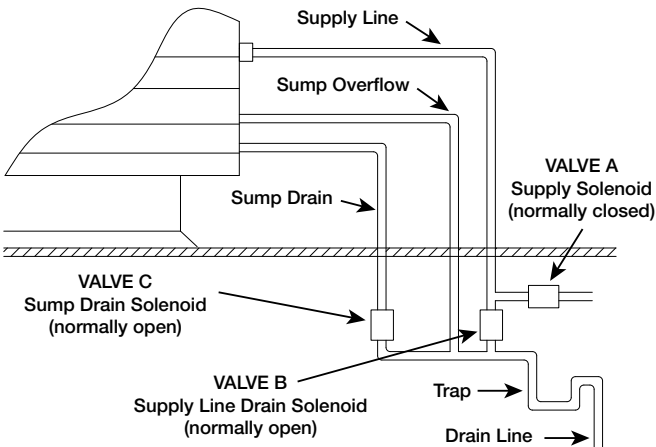

Mfg. Part Number	ASCO Part Number	Solenoid Type	De-Energized Position	Diameter	Qty.
461262	8210G2	Supply	Closed	1/2 inch (13 mm)	1
461263	8262G262	Supply Line Drain	Open	1/4 inch (6 mm)	1

Part numbers subject to change.

All three solenoid valves are different. Make sure to use the proper solenoid for each location. Check your local code requirements for proper installation of this type of system.

Note: The valves can be provided by the factory or field-supplied by others. If field-supplied valves are utilized, the total inrush VA shall not exceed 160 VA and the total holding VA shall not exceed 66 VA with a 24 VAC supply.

All solenoid valves and traps must be installed below the roof to protect the supply water line from freezing. If they cannot be installed below the roof, an alternative method must be used to protect the lines from freezing.

Auto Drain & Fill Valves (when provided by manufacturer)						
Assm. Number	Mfg. Part Number	ASCO Part Number	Solenoid Type	De-Energized Position	Diameter	Qty.
852178	461262	8210G2	Supply	Closed	1/2 inch (13 mm)	1
	461263	8262G262	Supply Line Drain	Open	1/4 inch (6 mm)	1
	461264	8210G35	Sump Drain	Open	3/4 inch (19 mm)	1

Part numbers subject to change.

### CAUTION

Provisions must be taken to prevent damage to the evaporative cooling section during freezing conditions. The sump, drain lines and supply lines must be drained prior to freezing conditions or an alternate method must be used to protect the lines and media.



### Optional Evaporative Cooling Module *(continued)*

#### 1. Install the Water Supply Line

Supply line opening requirements vary by unit size and arrangement. Connect the water supply line to the float valve. A field-provided opening must be created for the supply line.

The supply line must be of adequate size and pressure to resupply the amount of water lost due to bleed-off and evaporation. The drain line should be the same size or larger than the sump tank drain connection.

**Auto Drain and Fill or Single Pass** - Install the 1/2 in. normally closed solenoid (Valve A) in the supply line. Install the 1/4 in. normally open solenoid (Valve B) between the supply line and the drain line.

#### 2. Install the Drain Line

**Recirculating Pump** - Connect an unobstructed drain line to the drain and overflow connections on the evaporative cooling module. A shut off valve (by others) is required in the drain line. A trap must be provided for proper unit drainage.

**Auto Drain and Fill** - Connect an unobstructed drain line to the sump overflow connection. Install the 3/4 in. normally open solenoid (Valve C) between the sump drain connection and the drain line. A trap must be provided for proper unit drainage.

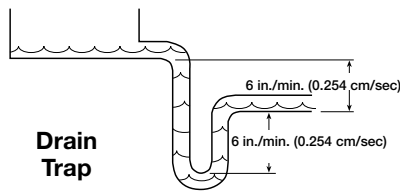

**Single Pass** - Connect an unobstructed drain line to the sump drain and overflow connections. A trap must be provided for proper unit drainage.

#### 3. Check/Adjust Water Level

Check the water level in the sump tank. The water level must be above the pump intake and below the overflow. Adjust the float as needed to achieve the proper water level. The float can be adjusted by bending the float lever arm. The single pass system does not use a float valve and does not retain water in the sump tank.

Note: The manufacturer recommends that units equipped with evaporative cooling be installed outdoors. If an evaporative cooling module must be installed indoors, it is recommended that a field-supplied secondary drain pan be installed under the evaporative cooling section. This will help mitigate damage to building materials in the event the evaporative cooling module sump tank overflows.

### Optional Chilled Water Coil

Guidelines for the installation of chilled water cooling coils have been provided to ensure proper performance and longevity of the coils. These are general guidelines that may have to be tailored to meet the requirements of a specific installation. Qualified personnel must perform the installation and maintenance of any coil. Proper protective equipment is recommended during the installation and maintenance of the coil.

When installing couplings, do not apply undue stress to the connection. Use a backup pipe wrench to avoid breaking the weld between the coil connection and the header.

All field-piping must be self-supporting. System piping must be flexible enough to allow for the thermal expansion and contraction of the coil and piping.

#### 1. Verify Coil Hand Designation

Check the coil hand designation to ensure that it matches the system. Coils are generally plumbed with the supply connection located on the bottom of the leaving air-side of the coil and the return connection at the top of the entering air-side of the coil. This arrangement provides a counter flow heat exchanger and positive coil drainage.

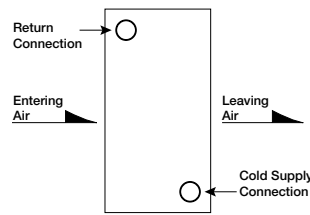

#### 2. Connect the Supply & Return Lines

Connect the supply and return lines as shown.

#### 3. Check the System for Leaks

Pressurize the system to 100 psig. Leave the system pressurized for a minimum of 10 minutes. If the system holds pressure, it can be considered leak free. If the pressure drops by 5 psig or less, re-pressurize the system and wait another 10 minutes. If the pressure drops again, there is likely one or more small leaks which must be located and repaired. Pressure losses greater than 5 psig indicate a large leak that must be isolated and repaired.

#### 4. Install the Drain Line

Connect an unobstructed drain line to the drain pan. A trap must be provided for proper unit drainage.

All traps must be installed below the roof line or be otherwise protected from freezing.

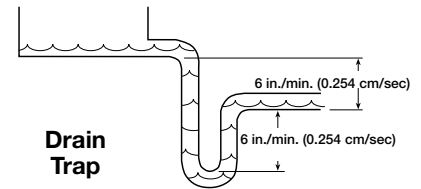

# Installation

## Optional Components

### Building Pressure Control

#### 1. Mounting Pressure Sensor

Using the factory provided bracket, mount the pressure sensor outside of the building. The pressure sensor mounting location must be out of prevailing winds and away from supply or exhaust fans to assure accurate readings.



#### 2. Running Pressure Tap Lines

Connect and run a pressure tube from the pressure sensor outside of the building to the low pressure tap on the back of the Photohelic® gauge. Run a second pressure tube from the high pressure tap on the back of the Photohelic gauge to the space. If the Photohelic gauge is located in the space to be controlled, the high pressure tube is not required.

Note: Fifty feet of tubing is supplied with the unit. If further tubing is required, this must be supplied by others.

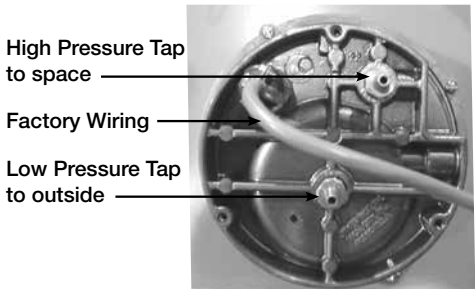

Connections for Photohelic® Gauge

#### 3. Setting the Desired Building Pressure

The Photohelic pressure gauge is used to set the desired building pressure. The pressure is set by adjusting the upper and lower pressure limits. A typical positive pressure setting is: 0.0 in. wg (0.0 kPa) for the lower and 0.10 in. wg (0.02 kPa) for the upper pressure setting.

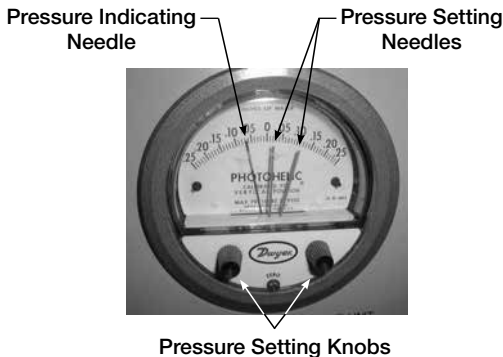

### Duct Pressure Control

The optional microprocessor controller can be selected to modulate the supply fan based upon a comparison of the duct static pressure set point to the actual duct static pressure level reported from the sensor. The factory-supplied sensor will ship loose for field-mounting and wiring. Further component identification and terminal designation can be found by referencing the unit specific ladder diagrams and supplemental material supplied with the unit.

# Supply Fan

## Fan Identification

The fan type must be identified before performing the supply fan pre-start checks and start-up. The unit was supplied with one of three fan options.

### Forward-Curved Fans

The forward-curved fans utilized in these units are double width, double inlet, belt driven, housed centrifugal fans. The impeller is constructed with shallow blades that “scoop” the air. In some instances, Models VSU or TSU units use two forward-curved fans with a common shaft.

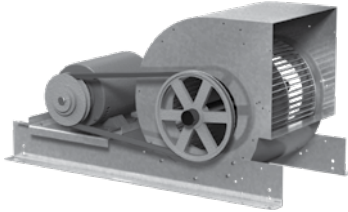

Forward-Curved

### Backward-Curved Plenum Fans

Backward-curved plenum fans are single width, single inlet fans. The impellers are unshoused, with blades that curve away from the direction of rotation. These fans throw the air radially outward, 90° from the inlet direction, pressurizing the fan cabinet. These fans are direct driven with the impeller mounted directly to the motor shaft. A “P” is present in the model number.

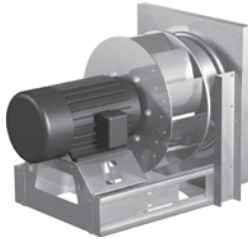

Backward-Curved Plenum

### Mixed Flow Plenum Fans

Mixed flow plenum fans are single width, single inlet fans. The impellers are unshoused with blades that curve away from the direction of rotation. These fans throw the air radially outward, approximately 45° from the inlet direction, pressurizing the fan cabinet. These fans are direct driven with the impeller mounted directly to the motor shaft. A “P” and “MF” are present in the model number.



Mixed Flow Plenum

### Punker

Hybrid Centrifugal Plenum Fans. Hybrid centrifugal plenum fans are single width, single inlet fans. The impellers are unshoused, with blades that curve away from the direction of rotation. These fans throw the air radially outward, approximately 90 degrees from the inlet direction, pressurizing the fan cabinet. These fans are direct driven with the impeller mounted directly to the motor shaft. A “P” and “D1 or D3” are present in the model number.

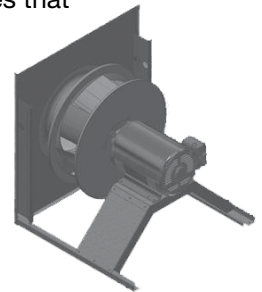

Hybrid Plenum Fan

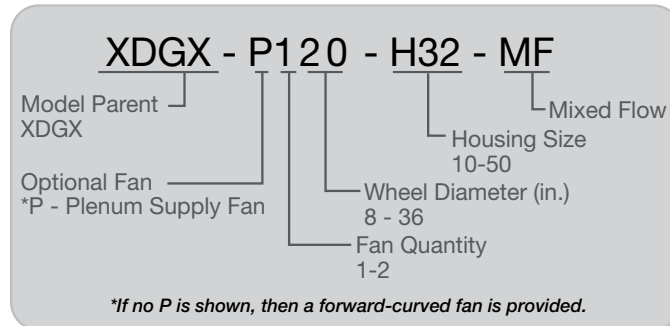

# Supply Fan

## Pre-Start Checks

### TOOLS REQUIRED

- Voltage Meter (with wire probes)
- Amperage Meter
- Pressure Gauges
- Tachometer
- Thermometer
- U-tube manometer or equivalent

### WARNING

Disconnect and lock-out all power and gas before performing any maintenance or service to the unit. Failure to do so could result in serious injury or death and damage to equipment.

Check the housing, fan, and ductwork for any foreign objects before running the fan.

Units with a direct drive backward-curved plenum supply fan must always be supplied with a Variable Frequency Drive (VFD) due to the direct drive arrangement on the supply fan. Before proceeding further, identify if this is a constant volume or Variable Air Volume (VAV) unit. A VAV unit will have a bypass damper located adjacent to the burner. Reference the *Start-Up: Direct Gas-Fired Heating, Optional Features, Variable Air Volume* section in this Installation, Operation, and Maintenance Manual for further information.

### 1. Check Fasteners for Tightness

Check fasteners, set screws and locking collars on the fan, bearings, drive, motor base, and accessories for tightness.

### 2. Check Supply Fan Clearance

The rotation of the supply fan wheel is critical. It must be free to rotate without striking or rubbing any stationary objects.

### 3. Check V-Belt Alignment (if applicable)

Check the V-belt drive for proper alignment and tension. Check the tension by measuring the deflection in the belt as shown.

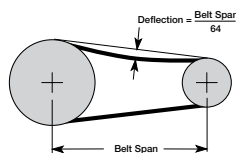

Belt Tension

Check the alignment by using a straight edge across both sheaves. Differences in sheave width must be accounted for.

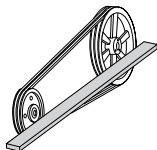

Drive Alignment

### 4. Check Plenum Fan Radial Overlap, Offset, Gap, and Wheel Alignment (if applicable)

#### Backward-Curved Plenum Fan Radial Overlap

Proper wheel and inlet cone overlap is shown in the chart. The overlap can be adjusted by loosening the setscrews in the wheel and moving the wheel to the correct position.

Fan Size	Overlap in. (cm)
P114	0.14 (0.36)
P115	0.25 (0.64)
P120	0.20 (0.51)
P125	0.26 (0.66)
P128	0.28 (0.71)

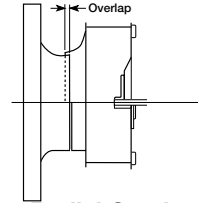

Backward-Curved Plenum Fan Radial Overlap

#### Backward-Curved Plenum Fan Radial Offset

Radial offset is adjusted by loosening the wheel hub from the shaft and moving the wheel to the desired position along the shaft. The correct radial offset between the inlet cone and wheel is shown in the chart. There is a smooth feel to the profile when moving from one component to the other.

Fan Size	Offset in. (cm)
P127	0.375 (0.95)
P222	0.250 (0.64)
P227	0.375 (0.95)

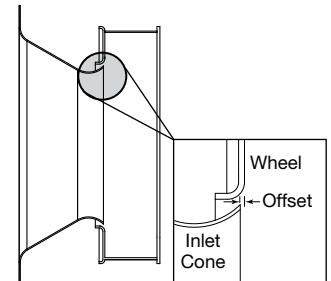

Backward-Curved Plenum Fan Radial Offset

#### Mixed Flow Plenum Fan Alignment

If necessary, adjust wheel position by loosening the wheel hub from the motor shaft. Adjust wheel position so that a straight edge held tight to the wheel cone just touches the inlet cone.

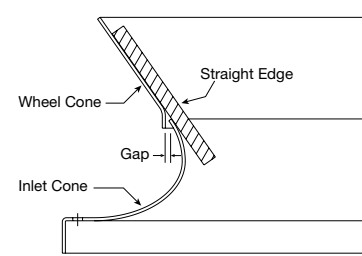

Mixed Flow Alignment

#### Hybrid Centrifugal Plenum Fan

If necessary, adjust wheel position by loosening the wheel hub from the motor shaft. Adjust wheel position so that a straight edge held tight to the wheel cone just touches the inlet cone.

Housing	Model	Wheel Overlap
H12	400 Dlight	.16"
H22	560 Dlight	.22"
H32	630 Dlight	.25"
H32	630 Dclassic	.25"
H32	630 Dprime	.25"

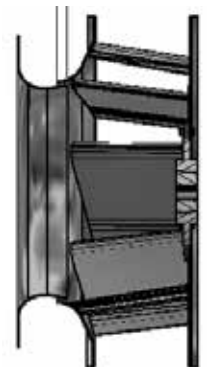

# Supply Fan

## Start-Up

### 1. Check Voltage

Before starting the unit, compare the supplied voltage, hertz, and phase with the unit and motor(s) nameplate information.

### 2. Check the Fan Rotation

Open the fan access door and run the fan momentarily to determine the rotation. If the fan is rotating in the wrong direction, the unit will move some air, but will not perform as designed. Be sure to perform a visual inspection to guarantee the correct fan rotation. Refer to the arrows to indicate the proper direction. To reverse the rotation of a three phase units, disconnect and lock-out the power, then interchange any two motor leads. To reverse the rotation of a single phase units, disconnect and lock-out the power, then rewire the motor per the manufacturer's instructions.

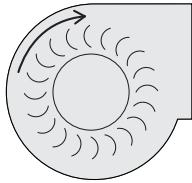

**Forward-Curved Fan Rotation**

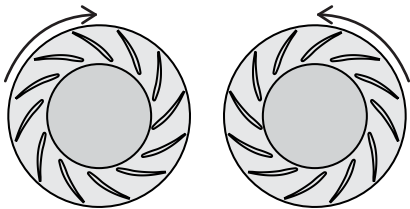

**Backward-Curved Plenum Rotation**

*(May be clockwise or counterclockwise as viewed from inlet)*

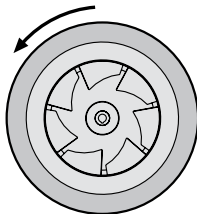

**Mixed Flow Plenum Rotation**

*(Always counterclockwise as viewed from inlet)*

### 3. Check for Vibration

Check for unusual noise, vibration or overheating of the bearings.

Excessive vibration may be experienced during the initial start-up. Left unchecked, it can cause a multitude of problems including structural and/or component failure.

Generally, fan vibration and noise is transmitted to other parts of the building by the ductwork. To minimize this undesirable effect, heavy canvas duct connectors can be used.

### 4. Motor Check

Measure the motor's voltage, amps and RPM. Compare to the specifications. Motor amps can be reduced by lowering the fan RPM or increasing system static pressure.

Additional starters and overloads may be provided in the make-up air control center for optional external exhaust fans. Exhaust fan motor voltage must match unit nameplate voltage. Exhaust fan overloads must be set to exhaust fan motor Full Load Amps (FLA). Reference the exhaust fan manual for additional information.

### 5. Air Volume Measurement

To ensure accuracy, the dampers are to be open when measuring the air volume.

Measure the unit's air volume and compare it with its rated air volume. If the measured air volume is incorrect, adjust the fan's RPM by adjusting the variable pitch sheave, if equipped, or replacing the sheave(s) if necessary. Direct drive fan RPM must be adjusted by changing VFD parameters. Consult factory for more information.

The most accurate way to measure the air volume is by using a pitot traverse method downstream of the fan.

Changing the air volume can significantly increase the motor's amps. If the air volume is changed, the motor amp draw must be checked to prevent overloading the motor.





# Pre-Start: Direct Gas-Fired Heating

## Ignition Control Identification

### Industrial Pilot

Typical ignition control for industrial pilot.

- All Industrial Pilot Systems are 120V



### Commercial Pilot

Typical ignition control for commercial pilot.

- A 24V Commercial Pilot System is used with  $\leq 18$  inch burners
- A 120V Commercial Pilot System is used with  $< 18$  inch burners



## Gas Train Identification

### Typical Pilot System with Combined Shut-off Valve and Regulator

This is a typical gas train. The gas train in your unit may be different.

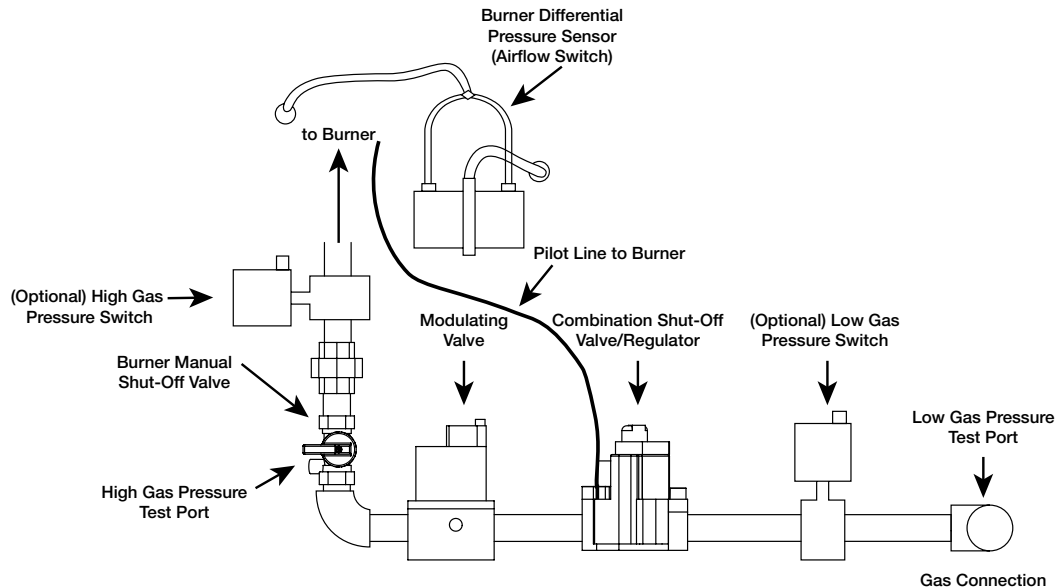

# Pre-Start: Direct Gas-Fired Heating

## Gas Train Identification

### Typical Pilot System with Separate Modulating Valve and Regulator

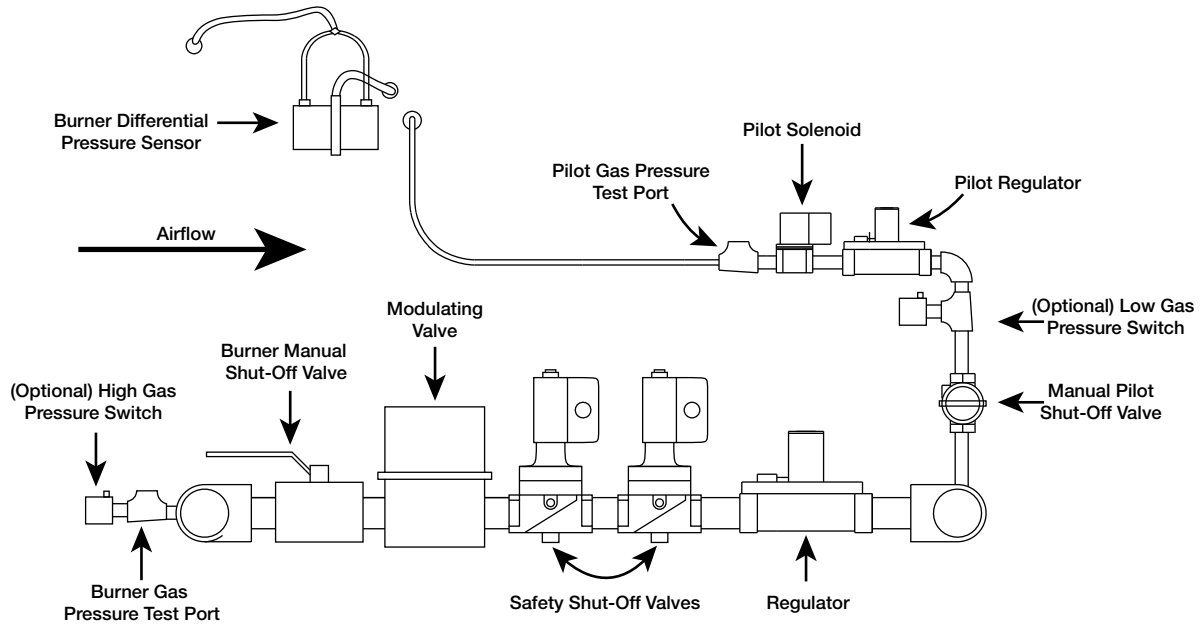

### Typical Pilot System with Combined Modulating Regulator

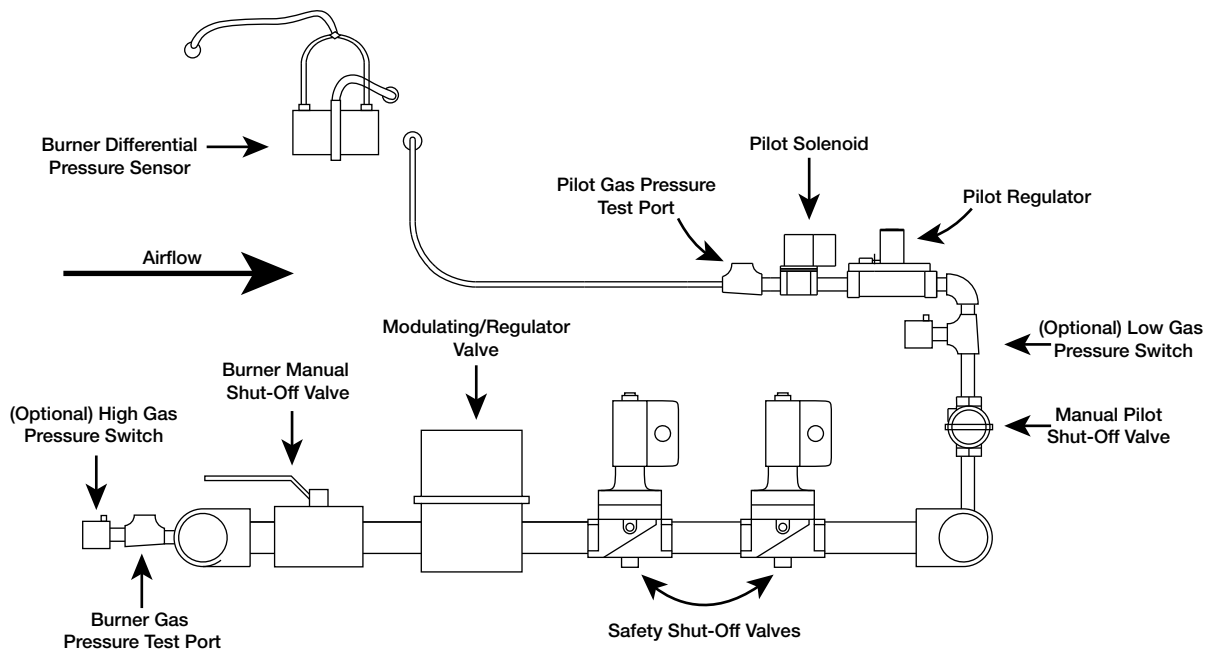

## Accessory Identification

### Temperature Control Identification

There are multiple control methods available for controlling the burner firing rate depending upon which Maxitrol System was supplied with the unit. Identify the system to better prepare for start-up and identify any optional shipped loose accessories for installation.

#### Maxitrol 14 Series Amplifier

This system is used to maintain a constant discharge air temperature when a call for heat is active. There are varying versions of this amplifier.

Discharge temperature reference DIP switch (remote or integral)



Low fire start time delay DIP switch

Set the discharge temperature  
 Typical 65°F (18°C)  
 Minimum: Typical: 55°F (13°C)  
 Maximum: Typical: 90°F (32°C)

#### Maxitrol Series 14

Optional shipped loose accessories include a remote temperature dial or a room override thermostat.



Remote Selector Dial



Room Override Control

#### Maxitrol 44 Series Amplifier

This system is used to maintain a room temperature set point when a call for heat is active. There are varying versions of this amplifier but they will always include at least one shipped loose accessory.

Low fire start time (LFST) DIP switch



Minimum discharge temperature setting  
 Typical: 50°F (10°C)

Maximum discharge temperature setting  
 Typical: 100°F (38°C)

#### Maxitrol 44 Series

Optional shipped loose accessories include a remote temperature sensor, Selectrstat and remote selector dial. The room temperature sensor and selector can be combined as one with the selector dial on the face or this system can be provided with the sensor body and the dial as separate components.



Room Temperature Sensor



Selectrstat



Remote Selector Dial

## Accessory Identification

### Temperature Control Identification

(continued)

#### Maxitrol SC Series Amplifier

This system requires that an analog control signal be provided to control the burner firing rate. This signal can be a 0-10 VDC or a 4-20 mA control signal and is provided by others unless the unit has been outfitted with a microprocessor controller. If this is the case, reference the supplemental *Microprocessor Controller for Make-Up Air Reference Guide* for more information. Typically the SC Series amplifier is wired to an owner-supplied Building Management System which provides the signal to vary the burner firing rate.

Note: The SC Series amplifier also limits the minimum and maximum discharge air temperatures. Reference the unit specific wiring diagram and Maxitrol data sheets included in the packet for further reference.

All 3 DIP switches must be positioned to the ON or OFF position based on signal being sent.

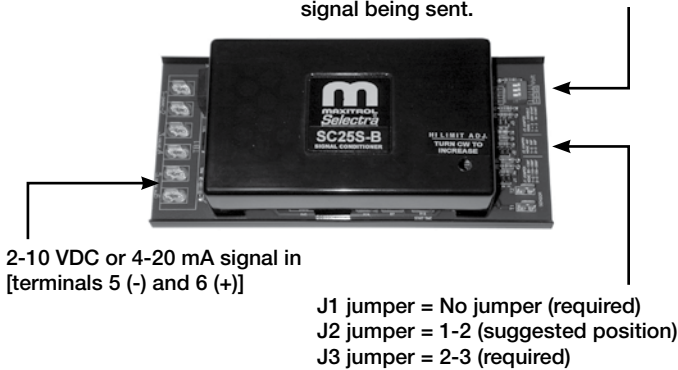

Maxitrol SC Series

#### Maxitrol SC-11 Signal Conditioner

This system is used to condition the 0-10 VDC output from the microprocessor controller to a 0-24 VDC output to the modulating valve. If the unit is equipped with this system reference Appendix for the start-up procedure and the supplemental *Microprocessor Controller for Make-up Air Reference Guide* for more information.



### High/Low Gas Pressure Switch(es)

An optional high and/or low gas pressure switch(es) may have been provided with the unit. The location of these switches is shown in the *Pre-Start-Up: Direct Gas-Fired Heating, Gas Train Identification* section in this Installation, Operation and Maintenance Manual. The high gas pressure switch will automatically shutdown and lockout burner operation if the manifold gas pressure is too high. The low gas pressure switch will automatically shutdown and lockout burner operation if the inlet gas pressure is too low. Both gas pressure switches will require a manual reset. The manual reset is a push button located on the top of the pressure switches.

The pressure thresholds are factory set but can be adjusted if necessary.

	Model No.
High Pressure	Honeywell C6097B1028
Low Pressure	Honeywell C6097A1012

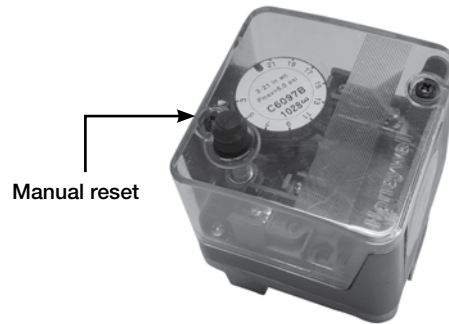

Typical Gas Pressure Switch

### UV Scanner

The optional UV scanner is a flame sensing device that can be used in lieu of a flame rod. The UV eye senses the flame by detecting the ultraviolet light produced by the flame. A special spark generator and rectification amplifier card are required with the use of this option.



# Start-Up: Direct Gas-Fired Heating

## All Units

For proper unit function and safety, follow the start-up procedure in the exact order that it is presented.

This start-up should begin after all of the installation procedures and the supply fan start-up have been completed.

If the unit is equipped with a microprocessor controller (see image) then reference Appendix A for detailed start-up procedure. If the unit is not equipped with the microprocessor controller continue following this section for start-up.



Microprocessor Controller

### 1. Check the Supply Gas Pressure

Check the supply gas pressure and compare it with the unit's nameplate pressure requirements. Adjust the supply regulator as needed until the supply gas pressure is within the specified range. The nameplate is located on the outside of the unit on the control panel side.

Minimum gas pressure for maximum output

	MAX. BTUHR. BTUJH MAX. <b>464,000</b>	MIN. BTUHR. BTUJH MIN. <b>32,000</b>	
	NORMAL MANIFOLD PRESSURE PRESSION D'ADMISSION NORMALE <b>5</b> "W.C.	MIN. GAS PRESSURE FOR MAX. OUTPUT PRESSION DE GAZ MIN. POUR PUISSANCE MAX. <b>10</b> "W.C.	←
	MIN. GAS PRESSURE PRESSION DE GAZ <b>6</b> "W.C.	MAX. GAS PRESSURE PRESSION DE GAZ MAX. <b>0.5</b> PSI	←
Type of gas	MIN. BURNER PRESSURE DROP PERTE MIN. DE PRESSION DANS LE BRULEUR <b>0.2</b> "W.C.	MAX. BURNER PRESSURE DROP PERTE MAX. DE PRESSION DANS LE BRULEUR <b>1.2</b> "W.C.	←
	TYPE OF GAS NATURE DU GAZ <b>NATURAL</b>	DESIGN TEMP CHANGE DESIGN TEMP NORMALE <b>85</b>	←

Maximum gas pressure

Direct Gas Nameplate

### 2. Check the Optional High and Low Gas Pressure Switches

The high pressure setting is typically 8 in. wg (2 kPa) and the low pressure is setting is typically 3 in. wg (0.7 kPa). The switches are set at the factory and should not need adjustment. Adjust the setting only if needed. Reference the *Pre-Start-Up: Direct Gas-Fired Heating, Gas Train Identification* section in this Installation, Operation and Maintenance Manual for the high and low pressure switch location.

The purpose of the high and low gas pressure switches is to automatically shut down the burner if the inlet gas pressure is too low for the burner to safely light, or if the manifold pressure is too high for the burner to operate properly.

### 3. Energize the unit control circuits (field-wiring shown on diagram with dashed lines)

- Exhaust fan (optional) - Connect terminals R to H
- Supply fan - Connect terminals R to G
- Heating - Connect terminals R to W1

### 4. Verify inlet air sensor (TS4) (if equipped)

Set inlet air sensor above the outside air temperature.

### 5. Verify supply fan rotation is correct

To reverse the rotation on three phase units, disconnect and lockout the power, then interchange any two power leads going to the motor. Check motor amp draw and compare to motor nameplate Full Load Amperage (FLA). Reduce airflow if amp draw is greater than FLA.

### 6. Set the Burner Air Pressure Differential

For units equipped with recirculation, reference the *Start-Up: Direct Gas-Fired Heating, Optional Features, Recirculation Operation* section in this Installation, Operation and Maintenance Manual for more information. For units equipped with variable air volume, reference the *Start-Up: Direct Gas-Fired Heating, Optional Features, Variable Air Volume* section in this Installation, Operation and Maintenance Manual for more information.

With all access panels in place, the fan running and discharging 70°F (21°C) air, connect a manometer to the burner differential sensing probes and measure the static pressure across the burner.

Proper air velocity over the burner is critical on direct gas-fired units. If the air velocity is not within the unit specifications, the unit will not operate efficiently, may have sporadic shutdowns, and may produce elevated by-products of combustion.

The proper static pressure should be between:

- Natural Gas:
  - 0.625 and 0.675 in. wg (156 and 168 Pa)
- Liquid Propane (LP) Gas:
  - 0.8 and 0.9 in. wg (200 and 224 Pa)

### Measuring the Pressure Drop

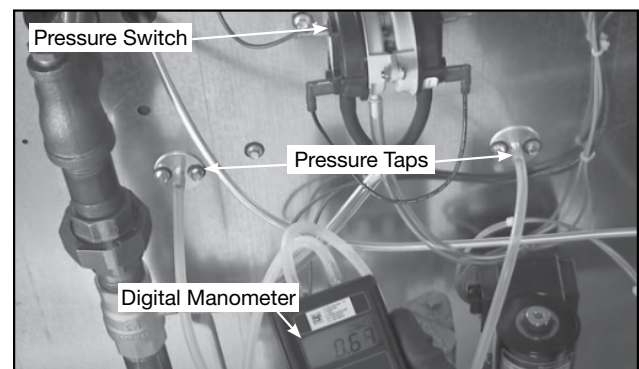

# Start-Up: Direct Gas-Fired Heating

## All Units

Adjust fan RPM via adjustable motor sheaves (if equipped), VFD (if equipped) or sheave replacement to achieve proper burner pressure drop. Motor amp draw must not exceed Full Load Amperage (FLA) on motor nameplate. If fan RPM cannot be adjusted. Make the necessary burner profile adjustment referring to Burner Wall (A) and Burner Wall (B) depending on your unit configuration. To increase the static pressure, decrease the opening. To decrease the static pressure, increase the opening. The pressure drop was set at the factory and may not need adjustment. When required pressure is obtained, be sure to reconnect the outer sensing probes.

If burner baffles have been adjusted, this process may need to be repeated until the proper pressure is achieved. This adjustment will change the air quantity delivered by the unit and therefore the air quantity delivered should be rechecked. Reference the *Supply Fan, Start-Up* section in this Installation, Operation and Maintenance Manual for more information.

### 7. Set the Low Fire Time Delay

Identify the type of Maxitrol amplifier installed. Reference the *Start-Up: Direct Gas-Fired Heating, Optional Features, Temperature Control Identification* section in this Installation, Operation and Maintenance Manual for more information. The Maxitrol Series 14 and Series 44 have a DIP switch to control the low fire start time. The Low Fire Start Time DIP switch must be set to the 10 second position. The Maxitrol SC Series must have the J3 jumper placed on pins 2 and 3 to ensure low fire start occurs.

### Burner Wall (A)

Variable Volume

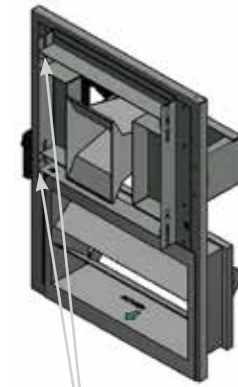

Adjust both baffle plates (above and below burner), evenly

Constant Volume



Adjust both baffle plates (above and below burner), evenly

### Burner Wall (B)

Variable Volume

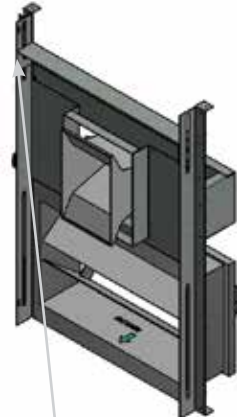

Adjust top profile plate up or down

Constant Volume

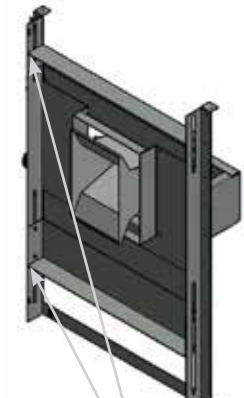

Adjust either top or bottom plate

## Ignition Control Identification

### 120V Honeywell



### 120V Baso



### 24V Baso



6" Burners



# Start-Up: Direct Gas-Fired Heating

## 120V Pilot System (Honeywell)

### 1. Energize the heating

Connect terminals R to W1.

### 2. Set pilot gas pressure

Close main hand valve, then set the pilot gas pressure to 1.5 - 3 in. wg. Measure DC voltage at flame signal test ports (+/-) on burner controller. Signal must be above 1.25 VDC and steady. Adjust pilot gas pressure up or down, if necessary, to achieve acceptable flame signal. In some cases, reducing pilot gas pressure can increase flame signal.



DC Voltmeter and Flame Amplifier

### 3. Set maximum fire rating

Open main hand valve and then set maximum firing rate to the design temperature rise found on the direct gas nameplate located on the outside of the unit on the control center side.

Send unit to high fire by removing the wire connected to terminal 3 of Maxitrol 14 or 44 Series amplifier. If equipped with the Maxitrol SC Series amplifier, remove the wires from terminals T1 and T2 and connect terminals T1 and T2 with a field-supplied jumper wire.

While measuring temperature rise,  $temperature\ rise = discharge\ temperature - inlet\ temperature$ , adjust the maximum firing rate to achieve desired temperature rise.

Remove cap to access maximum firing rate adjustment

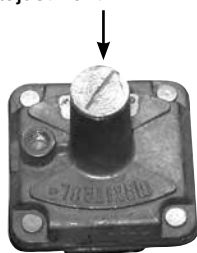

Remove one wire to send the unit to the minimum firing rate

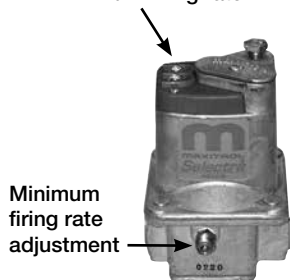

Separate Regulator and Modulating Valves

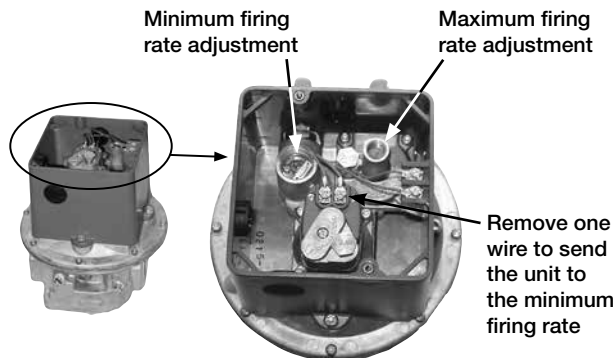

Combined Modulating Regulator

### 4. Set the minimum firing rate

Set the minimum firing rate to achieve a small ribbon of continuous blue flame across the burner.

Disconnect one of the wires going to the modulating valve and isolate. Set the minimum firing rate by adjusting the minimum firing rate adjustment on the modulating valve. Cycle the heat to make sure the burner can light at this low fire setting.

### 5. Resume normal operation

Reconnect wires to Maxitrol amplifier and modulating valve removed in previous steps.

### 6. Perform final flame signal check

Measure DC voltage at flame signal test ports (+/-) on burner controller. Signal must be above 1.25 VDC and steady. If flame signal is insufficient, repeat steps #1-4.



DC Voltmeter and Flame Amplifier

# Start-Up: Direct Gas-Fired Heating

## 120V Pilot System (Baso)

### 1. Energize the heating

Connect terminals R to W1.

### 2. Set pilot flame signal

Close main hand valve. Flame current must be measured with pilot valve lit but no main gas flowing. Set meter to  $\mu\text{A}$  DC scale. Locate flame signal terminals on the pilot ignition control, place red lead on [+] terminal and black lead on [-] terminal. The signal must be above 1  $\mu\text{A}$  DC. Adjust pilot gas pressure up or down, if necessary, to achieve acceptable flame signal. In some cases, reducing pilot gas pressure can increase flame signal.



Pilot Ignition Control

### 3. Set maximum fire rating

Open main hand valve and then set maximum firing rate to the design temperature rise found on the direct gas nameplate located on the outside of the unit on the control center side.

Send unit to high fire by removing the wire connected to terminal 3 of Maxitrol 14 or 44 Series amplifier. If equipped with the Maxitrol SC Series amplifier, remove the wires from terminals T1 and T2 and connect terminals T1 and T2 with a field-supplied jumper wire.

While measuring temperature rise,  $\text{temperature rise} = \text{discharge temperature} - \text{inlet temperature}$ , adjust maximum firing rate to achieve desired temperature rise.

Remove cap to access maximum firing rate adjustment

Remove one wire to send the unit to the minimum firing rate

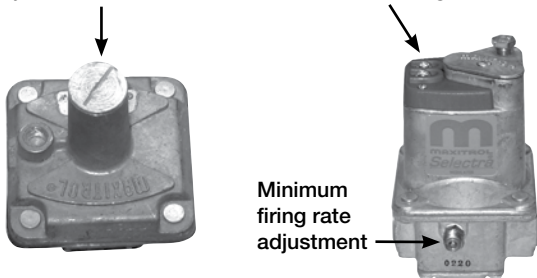

Separate Regulator and Modulating Valves

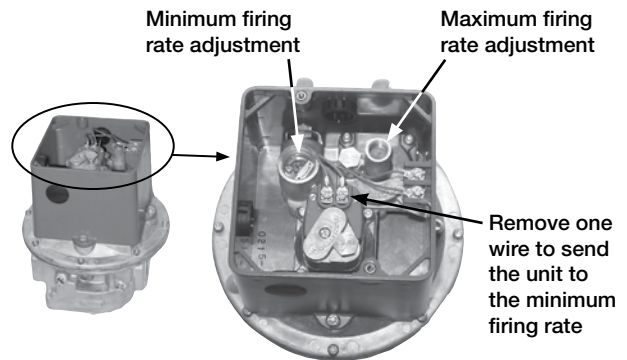

Combined Modulating Regulator

### 4. Set the minimum firing rate

Set the minimum firing rate to achieve a small ribbon of continuous blue flame across the burner.

Disconnect one of the wires going to the modulating valve and isolate. Set the minimum firing rate by adjusting the minimum firing rate adjustment on the modulating valve. Cycle the heat to make sure the burner can light at this low fire setting.

### 5. Resume normal operation

Reconnect wires to Maxitrol amplifier and modulating valve removed in previous steps.

### 6. Perform final flame signal check

Set meter to  $\mu\text{A}$  DC scale. Locate flame signal terminals on the pilot ignition control, place red lead on [+] terminal and black lead on [-] terminal. The minimum flame sense current is 1  $\mu\text{A}$  DC. If flame signal is insufficient, repeat steps #1-4.





# Start-Up: Direct Gas-Fired Heating

## 24V Commercial Pilot System (6-inch burner)

### 1. Energize the heating

Connect terminals R to W1.

### 2. Set pilot flame signal

Close main hand valve. Flame current must be measured with pilot valve lit but no main gas flowing. Set meter to  $\mu\text{A}$  DC scale. Locate flame signal terminals on the pilot ignition control, place red lead on [+] terminal and black lead on [-] terminal. The signal must be above 1  $\mu\text{A}$  DC. Adjust pilot gas pressure up or down, if necessary, to achieve acceptable flame signal. In some cases, reducing pilot gas pressure can increase flame signal.



Pilot Ignition Control

### 3. Set maximum fire rating

Open main hand valve and then set maximum firing rate to the design temperature rise found on the direct gas nameplate located on the outside of the unit on the control center side.

Send unit to high fire by removing the wire connected to terminal 3 of Maxitrol 14 or 44 Series amplifier. If equipped with the Maxitrol SC Series amplifier, remove the wires from terminals T1 and T2 and connect terminals T1 and T2 with a field-supplied jumper wire.

While measuring temperature rise, *temperature rise = discharge temperature - inlet temperature*, adjust combo valve regulator to achieve desired temperature rise.

Remove cap to access maximum firing rate adjustment

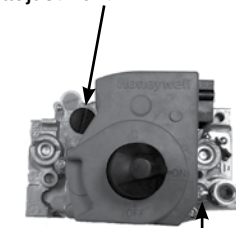

Pilot gas pressure adjustment

Remove one wire to send the unit to the minimum firing rate

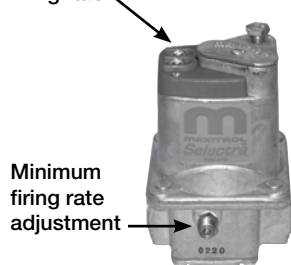

Minimum firing rate adjustment

Combination Valve Regulator and Modulating Valve

### 4. Set the minimum firing rate

Set the minimum firing rate to achieve a small ribbon of continuous blue flame across the burner.

Disconnect one of the wires going to the modulating valve and isolate. Set the minimum firing rate by adjusting the minimum firing rate adjustment on the modulating valve. Cycle the heat to make sure the burner can light at this low fire setting.

### 5. Resume normal operation

Reconnect wires to Maxitrol amplifier and modulating valve removed in previous steps.

### 6. Perform final flame signal check

Set meter to  $\mu\text{A}$  DC scale. Locate flame signal terminals on the pilot ignition control, place red lead on [+] terminal and black lead on [-] terminal. The minimum flame sense current is 1  $\mu\text{A}$  DC. If flame signal is insufficient, repeat steps #1-4.

# Start-Up: Direct Gas-Fired Heating

## Final Checks

### 1. Set the Unit's Operating Temperature

Set the operating temperature. The operating temperature setting depends on which Maxitrol controller is used.

#### Maxitrol Series 14

The Maxitrol Series 14 must be set to the desired discharge temperature reference. Place DIP switch in the "UP" position for local reference and in the "DOWN" position for remote reference. Keep low fire start time (LFST) DIP switch in the "UP" position at all times for 10 second delay. The remote dial shown in **Fig. A** is required for remote discharge temperature reference.

Discharge temperature reference DIP switch

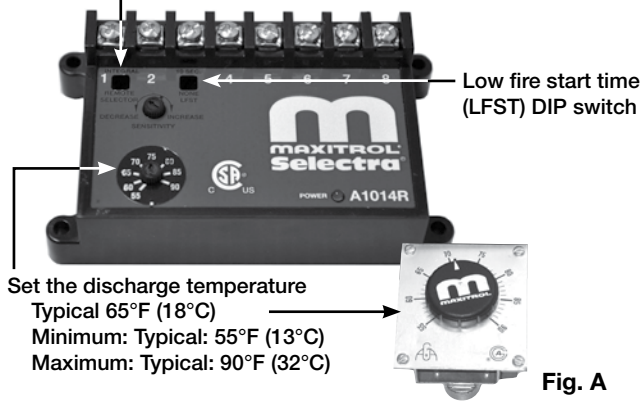

Fig. A

Maxitrol Series 14

#### Maxitrol Series 44

The Maxitrol Series 44 temperature selector must be set to the desired room temperature. The stand-alone dial may be mounted remotely. Keep low fire start time (LFST) DIP switch in the "up" position at all times for 10 second delay.

Set the space temperature  
Typical: 70°F (21°C)



Series 44 Temperature Selector

Low fire start time (LFST) DIP switch

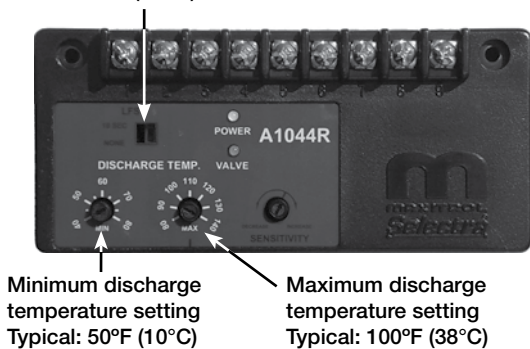

Maxitrol 44 Series

#### Maxitrol SC Series

Place jumpers and DIP switches as shown. If VDC input signal is supplied, all three DIP switches must be placed in the "OFF" position. If mA input signal is supplied, all three DIP switches must be placed in the "ON" position.

All 3 DIP switches must be positioned to the ON or OFF position based on signal being sent.

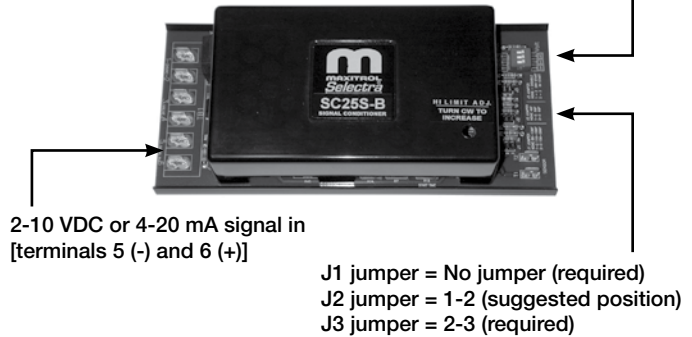

Maxitrol SC Series

### 2. Set-Up Optional Components

Adjust the settings on the optional components. Reference the *Reference, Control Center Layout* section in this Installation, Operation and Maintenance Manual for location of optional components.

- Heating Inlet Air Sensor  
Typical setting: 60-70°F (15.56-21.11°C)
- Cooling Inlet Air Sensor  
Typical setting: 75°F (23.89°C)
- Building Freeze Protection  
Typical setting: 5 minutes; 45°F (7.22°C)
- Dirty Filter Switch  
Typical setting: Settings vary greatly for each unit. Reference *Start-Up: Optional Features, Other, Dirty Filter Switch* section in this Installation, Operation and Maintenance Manual.



# Start-Up: Direct Gas-Fired Heating

## Optional Features

### Variable Air Volume (VAV)

Complete the *Supply Fan Pre-Start Checks and Start-Up* sections in this Installation, Operation and Maintenance Manual before proceeding.

For maintenance issues associated with a variable frequency drive (VFD), consult the drive's manual supplied with the unit. The drives are programmed at the factory and rarely need any adjustment during installation and start-up. For kitchen applications, the drive may be located in the kitchen or in the unit.

The VAV option is recommended when a building's exhaust volume may vary. This option enables the make-up air volume to track the exhaust volume, providing only the amount of make-up air required. Control strategies include 2-speed and modulating options. Before the unit is left in service, test the variable air volume control system.

### 2-Speed Option

A VFD is used on a single speed motor to control air volumes. The VFD is factory programmed for 2 speed operation and can be switched to low or high speed from a remote control panel. Turn the fan speed switch on the remote control panel to each position and confirm that the fan speed adjusts accordingly.

### Modulating Options

#### Potentiometer Control

A VFD is controlled by input from a remote speed selector (potentiometer). This option allows easy manual adjustment of make-up air volumes.

To test potentiometer operation, turn the potentiometer to the two extremes. Make sure the fan goes to maximum and minimum speed. When the potentiometer is at minimum, the fan speed will be at its minimum. When the potentiometer is at maximum, the fan will be at its maximum speed.

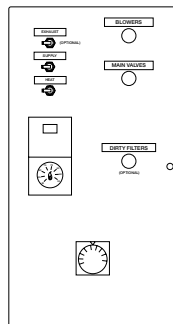

Potentiometer Control

#### Building Pressure Control

A VFD is controlled according to input from a pressure sensing device.

On the Photohelic® gauge, turn both pressure knobs to the upper most setting. The VAV system should go to maximum speed. Set both knobs at the lowest setting and the VAV system should go to minimum speed. Reset the correct pressure limits before starting the unit.

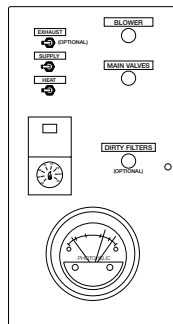

Building Pressure Control

Pressure Indicating Needle  
Pressure Setting Needles



Pressure Setting Knobs  
Photohelic® Gauge

Typical settings are 0.0 in. wg (0 kPa) for the lower pressure setting and 0.10 in. wg (0.02 kPa) for the upper pressure setting. The needle indicates a negative building pressure. During correct operation, the indicating needle will remain between or near the setting needles.

#### External Signal

A VFD is controlled according to input from an external 2-10 VDC or 4-20 mA signal (by others).

A 2 VDC or 4 mA signal will send the fan to low speed. The fan will go to maximum speed with a 10 VDC or 20 mA signal.

#### Variable Kitchen Control

A VFD is controlled by input from a speed control signal from the kitchen hood. This unit allows automatic adjustment of make-up air volumes based on varying cooking loads.

#### Burner Bypass Damper

The self-adjusting burner bypass damper is required for proper operation of variable volume units. It functions to maintain proper combustion by providing a constant airflow over the burner when outside air volumes are changed. It is located adjacent to the burner.

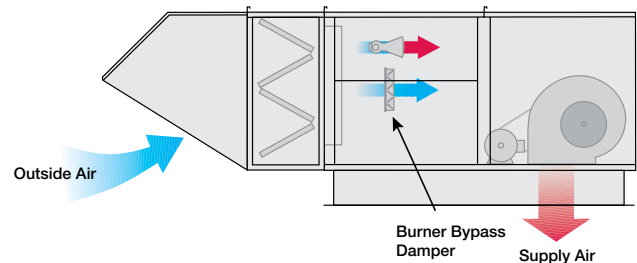

At design airflow, the bypass damper will be nearly open and approximately 50% of the total airflow will pass through the damper. The remaining air will pass over the burner. As the supply airflow is reduced, the bypass damper will begin to close. This reduces the amount of air passing through the damper and maintains a constant volume of air passing over the burner. At

### Variable Air Volume (VAV) *(continued)*

minimum airflow, the bypass damper will be mostly closed and a majority of the air will pass through the burner profile. In this way, the airflow through the burner profile remains relatively constant through the range of airflow operation.

Due to the movement of the bypass damper throughout the airflow range of the unit, a change in RPM does not result in a directly proportional change in airflow. In these units, a 33% fan RPM reduction results in a 50% airflow reduction.

### Burner Pressure Differential Check

The bypass damper is designed to open and close to maintain the correct pressure differential through the burner profile for proper operation. The counterbalance arm and weights are factory adjusted for the correct pressure drop and do not require field adjustment. In many cases, the bypass damper is able to compensate for variations in supply airflow and no adjustments to the burner profile are necessary.

Reference the *Start-Up: Direct Gas-Fired Heating, All Units* section in this Installation, Operation and Maintenance Manual for more information about measuring burner pressure differential and adjusting burner baffles. Before making any adjustments to the burner baffles on a variable air volume unit, check the burner pressure differential with the supply fan at maximum speed and again with the supply fan at minimum speed. The burner pressure differential will vary slightly throughout the range of airflow. Verify that the burner pressure differentials at maximum and minimum speed are both in the correct range:

- Natural Gas: 0.5 to 0.8 in. wg
- Liquid Propane (LP) Gas: 0.7 to 1.0 in. wg

If adjustment is necessary, adjust the fan RPM via adjustable motor sheaves (if equipped), VFD, or sheave replacement to achieve proper burner pressure drop. Motor amp draw must not exceed full load amperage (FLA) on motor nameplate. If fan RPM cannot be adjusted, evenly adjust the baffles above and below the burner, keeping the burner centered in the opening until the required pressure is obtained.



# Start-Up: Direct Gas-Fired Heating

## Optional Features

### Recirculation Operation

The recirculation operation option is recommended when the ventilation equipment provides the primary source of heating for the space or when exhaust fan tracking is required. A minimum of 20% outdoor air is mixed with up to 80% recirculated air. Control strategies include 2-position option and modulating options.

During commissioning, test the recirculation control system.

#### 2-Position Option

A 2-position spring return actuator is used to control the return air amounts. The damper moves from open to closed. If power is cut to the unit, the outdoor air damper will fail closed.

Turn the recirculating switch on the remote control panel to each position and confirm that the return air damper adjusts accordingly. The damper actuator may take a few minutes to open or close.

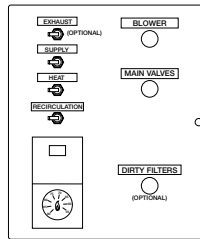

**2-Position Damper Control**

#### Modulating Options

##### Potentiometer Control

A modulating spring return actuator is used to control the return air amounts. The return air damper modulates from fully open to fully closed based on a signal from a remote potentiometer.

To test potentiometer operation, turn the potentiometer to the two extremes. Confirm that the return air damper fully opens and fully closes. When the potentiometer is at minimum, the return air damper will open. When the potentiometer is at maximum, the return air damper will close. The damper actuator may take a few minutes to open or close.

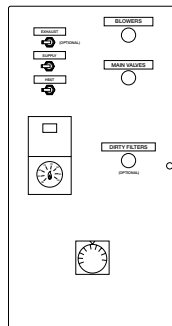

**Potentiometer Control**

##### Building Pressure Control

A floating point spring return actuator is used to control the return air amounts. The return air damper modulates from fully open to fully closed based on a signal from a remote pressure sensing device.

On the Photohelic® gauge, turn both knobs to the upper most pressure setting. You may have to remove the outdoor pressure tap tubing. The return air damper should close.

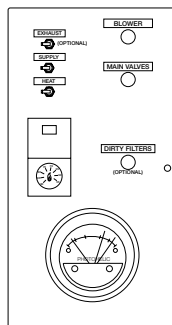

**Building Pressure Control**

Pressure Indicating Needle

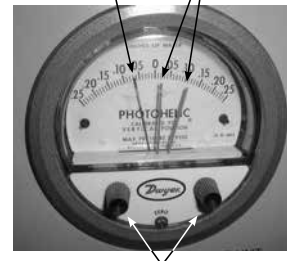

Pressure Setting Needles

Pressure Setting Knobs

**Photohelic® Gauge**

Set both knobs at the lowest setting and the damper should open. It may take one to two minutes for the damper to reach the desired position.

Reset the correct pressure limits before starting the unit.

Typical settings are 0.0 in. wg (0 kPa) for the lower and 0.10 in. wg (0.02 kPa) for the upper pressure setting. The needle in this photo indicates a negative building pressure. During correct operation, the indicating needle will remain between or near the setting needles.

##### External Signal

A modulating spring return actuator is used to control the return air amounts. Return air damper modulates from fully open to fully closed based on an external 2-10 VDC or 4-20 mA signal (by others).

The return air damper will close with a 10 VDC or 20 mA signal. The return air damper should open with a 2 VDC or 4mA signal. The damper actuator may take a few minutes to open or close.

### Recirculation Arrangements

There are two important design features that must be maintained by recirculating direct fired equipment. Recirculated air cannot be passed over the burner and airflow across the burner must remain constant throughout the range of recirculation. These units with recirculation meet both of these requirements and are able to operate with up to 80% recirculated air.

#### Recirculation with Filtered Return Air

Model XDGX is available with a recirculation design that includes integral filtration of the recirculated air. In this design, the inlet portion of the unit is divided into two airstreams. The upper airstream carries 20% of the total supply volume. This air enters the unit through a damper, passes through filters, and then across the burner where it is heated. The other 80% of the supply air passes through the lower airstream which includes a mixing box that controls the ratio of recirculated and outside air that is introduced. The air in the lower airstream passes through filters and is mixed with the heated outside air that passed across the burner. A bypass baffle is located under the burner in the bypass airstream to allow adjustment of the percentage of total supply air that is permitted to bypass the burner. This baffle may need to be adjusted to achieve a proper burner pressure differential.

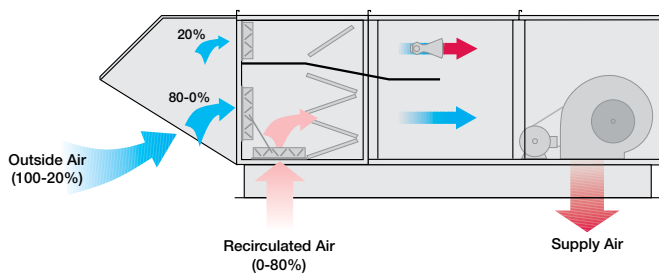

#### Burner Pressure Differential Check

The burner pressure differential on direct fired units with recirculation is affected by total airflow and the percentage of airflow that is passing over the burner. If too much air is allowed to bypass the burner, the burner pressure differential will be too low. If too little air is allowed to bypass the burner, the burner pressure differential will be too high.

Reference the *Start-Up: Direct Gas-Fired Heating, All Units* section in this Installation, Operation and Maintenance Manual for more information about measuring burner pressure differential and adjusting burner baffles. Before making any adjustments to the burner baffles on a unit with recirculation, measure the burner pressure differential with the recirculation damper fully closed and again with the recirculation damper fully open. The burner pressure differential will vary slightly as the percentage of recirculated air varies. Verify that the burner pressure differential is in the correct range throughout the operating range of the recirculation damper:

- Natural Gas: 0.5 to 0.8 in. wg
- Liquid Propane (LP) Gas: 0.7 to 1.0 in. wg

If adjustment is necessary, adjust the fan RPM via adjustable motor sheaves (if equipped) or sheave replacement to achieve proper burner pressure drop. Motor amp draw must not exceed full load amperage (FLA) on motor nameplate. If fan RPM cannot be adjusted or proper burner pressure differential cannot be achieved by adjusting fan RPM, adjust the baffle located over the recirculated air damper (non-filtered recirculation) or the baffle located under the burner in the bypass airstream (filtered recirculation). Adjusting the recirculated air damper baffles or bypass baffles will adjust the percentage of air that is allowed to bypass the burner. Close the baffle(s) to raise the burner pressure differential. Open the baffle(s) to lower the burner pressure differential. If the recirculated air damper baffles or bypass baffle are adjusted as far as they will go, adjust the baffles on either side of the burner as necessary.

# Start-Up: Optional Features

## Evaporative Cooling Module

**Note:** For single pass, complete steps 1, 4, 5 and 6 only.

### 1. Check the Installation

The media may have been removed during installation, so its orientation should be checked. The media must be installed with the steeper flute angle sloping down towards the entering air side.

Verify that the stainless steel caps and distribution headers are in place. The headers are located over the media towards the entering air side. The caps must be placed over the headers.

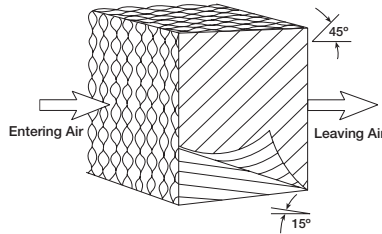

**Media Orientation**

### 2. Check the Pump Filter

Check that the pump filter is around the pump inlet.

### 3. Fill the Sump and Adjust the Float

Turn on the water supply and allow the sump tank to fill. Adjust the float valve to shut-off the water supply when the sump is filled to within 1 inch (2.54 cm) of the bottom of the overflow.

### 4. Break-In the Media

Open the ball valve completely and saturate the media with the fan(s) off for no less than 20 minutes.

A jumper will need to be installed in the control center to power the evaporative pumps or single pass valves with the fan(s) off. Reference the unit's ladder diagram to determine proper terminals.

### 5. Put the Unit into Service

Remove the jumper and energize the fan(s). Verify proper operation.

### 6. Check the Flow Rate

The pumps or water supply should provide enough water to saturate the media in 45 to 60 seconds with the fan running. Consult the factory if adequate flow is not achieved.

If too much water is flowing to the media, the flow can be adjusted using the manual ball valve. If flow adjustments are made, verify that sufficient water is still being supplied to the media to keep the entire pad wet during normal operation. Excessive water flow can result in water carryover problems. Insufficient water flow can result in mineral build-up.



**Manual Ball Valve**

### 7. Adjust the Water Bleed-Off Rate

The water bleed-off rate is dependent on the water's mineral content. After two weeks of service, adjust the bleed-off rate to eliminate mineral deposits on the media.

### 8. Set the Optional Auto Drain and Fill

This system will automatically drain the sump pan and fill it with fresh water at the field-adjustable intervals (factory default is once every 24 hours). The auto drain sequence reduces the mineral concentration within the sump pan to reduce maintenance and increase media pad life.

In addition, this system will protect the evaporative cooling module from freezing by draining the sump tank and supply line when the outside temperatures fall below the set point of the outside air sensor. This is set to 45°F (7.2°C) and is not adjustable.

#### Set the Timer Scale and Settings dials:

- **T1** timer setting set to **10** and timer scale set to **1d** for 1 day of operation
- **T2** timer setting set to **10** and the timer scale set to **10m** for 10 minutes of drain time

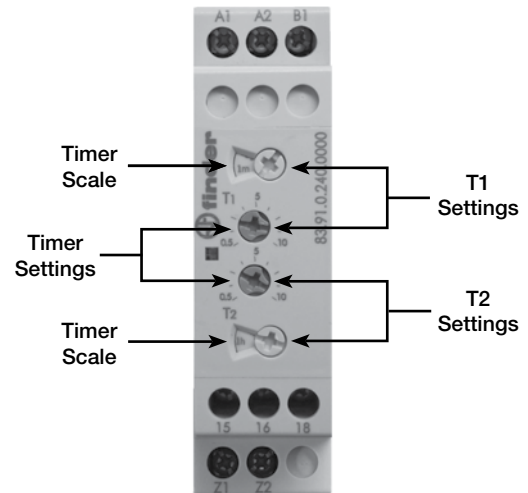

**Auto Drain and Fill Timer**

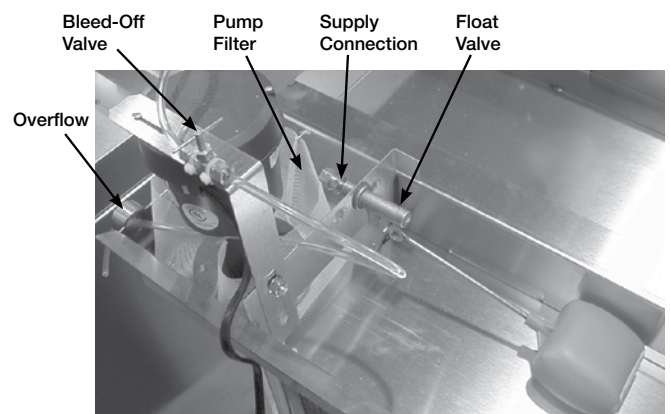

**Evaporative Cooling Module Set-Up**

## Start-Up: Optional Features

### Other

#### Building Freeze Protection

This option is intended to disable the unit supply fan in the event the discharge temperature falls below 35°F for five minutes. This is accomplished through electromechanical controls or a microprocessor. Building freeze protection is selected when the unit may operate while the space it serves is unoccupied.

#### Carbon Dioxide (CO<sub>2</sub>) Sensor

This sensor is intended to measure the CO<sub>2</sub> concentration in the ventilated space or return air duct. If the unit has been equipped with a microprocessor controller, the CO<sub>2</sub> sensor will modulate either the VFD or the return and outside air dampers based upon a comparison of the CO<sub>2</sub> set point to the actual CO<sub>2</sub> levels reported from the sensor. The duct mount or room mount sensor is shipped loose for field mounting and wiring.

#### Duct-Mounted Smoke Detector

The duct smoke detector provides early detection of smoke present in the HVAC duct system. The smoke detector is designed to prevent the recirculation of smoke by the air handling system. Complete system shut down will occur in the event of smoke detection. The detector will operate on 115 or 24 VAC. Output terminals are provided for remote accessories such as a horn, strobe, remote status indicators and reset switches or push buttons.

#### Microprocessor Controls

The controller has been pre-programmed to offer multiple control sequences for providing tempered air. Easy monitoring and adjustment of unit parameters can be accomplished by way of the lighted graphical display and an integral push-button keypad or by way of the Building Management System (BMS) communication with the addition of an optional BMS communication card. This addition allows the user too remotely adjust set points, view unit status points and alarms. The sequence parameters are fully adjustable. For additional information, reference the supplemental Microprocessor Controller for Make-Up Air Reference Guide for more information.

#### Packaged Direct Expansion (PDX) Cooling Module

The PDX module is a complete package that has been designed for outdoor installations. The PDX system in the module is a complete, sealed unit with compressed R-410A refrigerant. It consists of one or two compressors, evaporator and condenser coils, and all other necessary components. Reference the supplemental *Packaged DX Module* Installation, Operation and Maintenance Manual for more information.

#### Dirty Filter Switch

To adjust the switch, the unit must be running with all of the access doors in place, except for the compartment where the switch is located. The filters must be clean and in good condition. The adjusting screw is located on the top of the switch.

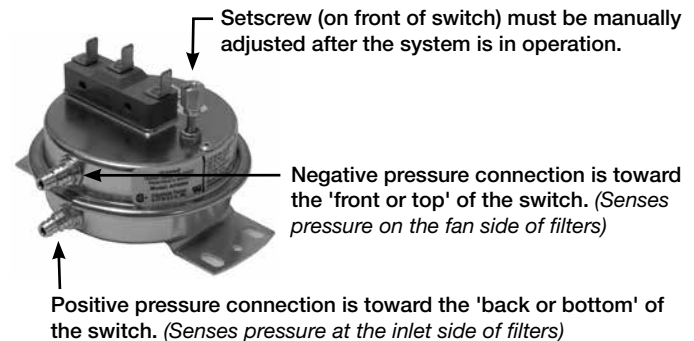

1. Open the filter compartment and place a sheet of plastic or cardboard over 50% of the filter media.
2. Close and secure the filter compartment door.
3. Check to see if there is power at the alert signal leads (refer to electrical diagram).
4. If power is present, turn the adjustment screw counterclockwise until the power goes off. Turn slightly clockwise until power comes back on. If power is not present, turn the adjustment screw clockwise until the power comes on.
5. Open the filter compartment and remove the obstructing material.
6. Close and secure the door and check to make sure there is no power at the alert signal leads. The unit is now ready for operation.

#### Heating and/or Cooling Inlet Air Sensor(s)

The heating inlet air sensor locks out heating operation when the inlet temperature rises above set point (field-adjustable). The cooling inlet air sensor locks out cooling when inlet temperature falls below set point (field-adjustable). These components are located in the unit's control center. Reference the unit's ladder diagram for component identification and terminal designation.

#### Inlet Damper End Switch

Provides a damper actuator with an end switch that is wired into the unit's control center. This will prevent the supply fan from starting up until the end switch is proven. Reference the unit's ladder diagram for component identification and terminal designation.





## Sequence of Operation

If the unit has a microprocessor, reference the supplemental *Microprocessor Controller for Make-Up Air Reference Guide* for more information.

### OPTIONAL EXHAUST

#### Exhaust Fan Contact (S1) Closed (optional)

- Power passes to normally closed exhaust overload contact (ST2 OL).
- Power passes to exhaust starter(s) ST2.
- Normally open exhaust starters are energized and closed.
- Power passes to exhaust fans.
- Exhaust fan(s) (M2) start.

### SUPPLY FAN

#### Supply Fan Contact (S2) Closed

- Power passes through normally closed field-supplied fire system contact (FSC).
- Power passes through normally open exhaust fan contact (ST2), which is closed when the exhaust relay (ST2) is activated (optional).
- Power passes to normally closed supply overload contact (ST1 OL or VFD).
- Power passes through normally closed contact on optional freeze protection timer (RT4) which remains closed if the temperature has remained above the set point.
- Power passes to optional inlet damper which opens.
- When damper is fully opened, optional normally open damper limit switch (DL1) closes.
- Power passes to and energizes supply starter relay (RF).
- Power passes to normally open fan contact (RF), which is energized and closed.
- Supply starter (ST1) or variable frequency drive (VFD) is energized.
- Supply starter contact (ST1) closes or VFD is energized and power reaches and energizes supply fan.
- Supply fan (M1) starts.

### HEATING

#### Heat Contact (S4) Closed

- Power passes to normally open fan relay (RF or ST1) which is energized and closed.
- Power passes to optional inlet air sensor contact (TS4) which is closed if the inlet air temperature is below the set point.
- Power passes to and energizes the heat relay (RH).
- Normally open heat relay contact (RH) closes.

### Commercial Flame Safeguard Ignition Sequence

- Power passes to normally closed high limit control contact (HLC1) which is closed if temperature has remained below set point.
- Power passes to optional normally open and normally closed high and low gas pressure contacts (PS4 and PS3), which are both closed if gas pressure is within the set range.
- Power passes to normally open and normally closed airflow switches (PS2) which are closed if there is proper airflow across the burner.
- Power passes to terminal TH on the flame safeguard (FSG).
- Flame safeguard checks for proper airflow and completes verification of no flame present at burner.
- A 15 second prepurge is initiated.
- Power is passed to normally closed gas valve (V2) which opens and the spark generator (SG) is energized.
- The trial for ignition will last for up to 30 seconds or until flame is confirmed.
- Spark generator (SG) is de-energized.
- The flame and airflow are continuously monitored.

### Industrial Flame Safeguard Ignition Sequence

- Power passes to and energizes terminal 5 of the flame safeguard (FSG). Power light on FSG is on.
- Power passes to normally closed high limit control contact (HLC1) which is closed if temperature has remained below set point.
- Power passes to optional normally open and normally closed high and low gas pressure contacts (PS4 and PS3), which are both closed if gas pressure is within the set range.
- Power passes to terminal 6 of the flame safeguard (FSG).
- Flame safeguard checks for proper airflow and completes verification of no flame present at burner.
- A 10 second prepurge is initiated.
- Power is passed to normally closed pilot gas valve (V1) which opens and the spark generator (SG) is energized.
- The trial for ignition will last for up to 10 seconds or until flame is confirmed.
- After flame is confirmed, power is passed to the normally closed main gas valves (V2) which open.
- Spark generator (SG) is de-energized.
- The flame and airflow are continuously monitored.
- A self-diagnostic check is performed every five seconds.

# Sequence of Operation

## OPTIONAL COOLING

### Optional Cooling Contact (S4) Closed

- Power passes to normally open fan relay (RF or ST1) which is energized and closed.
- Power passes to optional inlet air sensor contact (TS5) which is closed if the inlet air temperature is below the set point.
- Power passes to and energizes cooling relay (RC).
- Cooling sequence begins.

### Cooling Sequence - Recirculating Pump Evaporative Cooling

- Whenever the cooling relay (RC) is energized, power passes through the normally open cooling relay to the evaporative cooling pump (P1).
- The evaporative cooling pump(s) are energized and cooling begins.

### Cooling Sequence - Auto Drain and Fill Evaporative Cooling

- Power passes to the evaporative cooling module freeze sensor (FRZ) which is closed if the incoming air temperature is above the set point.
- Power passes to the auto drain and fill timer (TC) and the supply drain valve (VSD).
- The supply drain valve is energized and closed.

### Run Time Period

- During the run time period, the auto drain and fill timer (TC) passes power to the auto drain relay (RA) and to the auto drain valves (VS, VD).
- The normally closed supply valve (VS) is energized and opens. The normally open drain valve (VD) is energized and closes. The normally open supply drain valve (VSD) is energized and closes. This allows water to fill the evaporative cooling sump.
- When the cooling relay (RC) and the auto drain relay (RA) are energized, power passes through the normally open cooling relay (RC) contacts and the normally open auto drain relay (RA) contacts to the evaporative cooling pump(s) (P1).
- The evaporative cooling pump(s) are energized and cooling begins.

### Drain Time Period

- When the run time period expires, the auto drain relay (RA) and the auto drain valves (VS, VD) are de-energized. The drain time period begins.
- When the auto drain relay (RA) is de-energized, the normally open auto drain relay (RA) contacts open and the evaporative cooling pump(s) are de-energized.
- When the normally closed supply valve (VS) is de-energized, the water supply to the evaporative cooling module sump is stopped.
- When the normally open drain valve (VD) is de-energized, the evaporative cooling sump is drained.

## Freeze Condition

- If the incoming air temperature is below the evaporative cooling module freeze sensor (FRZ) set point, the freeze sensor (FRZ) contacts will open, de-energizing the auto drain and fill timer (TC) and the supply drain valve (VSD).
- When the normally closed supply valve (VS) and the normally open supply drain valve (VSD) are de-energized, the supply line is drained.
- When the normally open drain valve (VD) is de-energized, the evaporative cooling module sump is drained.

## Cooling Sequence - Chilled Water

- Modulating or staged controls for chilled water are supplied by others. The sequence of operation will depend on the controls provided.
- The cooling relay (RC) normally open contacts may be used to initiate the cooling sequence for the controls supplied by others.

## OPTIONAL VARIABLE VOLUME

### Two Speed VFD Control

- When the supply fan relay (RF) is energized, the normally open supply fan relay (RF) contacts are closed. This creates a run command for the VFD.
- The run command allows the VFD to pass power to the supply fan (M1). The supply fan (M1) will operate at maximum speed.
- When the two speed supply fan contact (S2) is switched to the low position, power is passed to the low speed relay (RL) which is energized.
- The normally open low speed relay (RL) contacts are closed commanding the VFD to low speed.
- The VFD controls supply fan M1 to operate at minimum speed.

### Potentiometer VFD Control

- When the supply fan relay (RF) is energized, the normally open supply fan relay (RF) contacts are closed. This creates a run command for the VFD.
- The run command allows the VFD to pass power to the supply fan (M1). The supply fan (M1) will operate at the speed commanded by the potentiometer.
- The potentiometer will output a 2-10 VDC signal to the VFD analog input terminal. A 2 VDC signal will command the VFD to minimum speed. A 10 VDC signal will command the VFD to maximum speed.
- The VFD controls the supply fan motor (M1) to the speed commanded by the potentiometer.



## Sequence of Operation

### External Signal VFD Control

- When the supply fan relay (RF) is energized, the normally open supply fan relay (RF) contacts are closed. This creates a run command for the VFD.
- The run command allows the VFD to pass power to the supply fan (M1). The supply fan (M1) will operate at the speed commanded by the external signal provided by others.
- The external signal provided by others will send a 2-10 VDC or a 4-20 mA signal to the VFD analog input terminal. A 2 VDC or 4mA signal will command the VFD to minimum speed. A 10 VDC or 20 mA signal will command the VFD to maximum speed.
- The VFD controls the supply fan motor (M1) to the speed commanded by the external signal.

### Building Pressure VFD Control

- When the supply fan relay (RF) is energized, the normally open supply fan relay (RF) contacts are closed. This creates a run command for the VFD.
- The run command allows the VFD to pass power to the supply fan (M1). The supply fan (M1) will operate at minimum speed.
- The photohelic building pressure controller will monitor the pressure differential between the pressure in the controlled space and the pressure outside the controlled space.
- If the pressure differential is below the set point range established on the photohelic controller, the VFD will increase the supply fan speed.
- If the pressure differential is above the set point range established on the photohelic controller, the VFD will decrease the supply fan speed.
- If the pressure differential is within the set point range established on the photohelic controller, the VFD will maintain the supply fan at its current speed.

### OPTIONAL RECIRCULATION

#### Two Position Recirculation Control

- Power passes to inlet damper which opens.
- When damper is fully opened, normally open damper limit switch (DL1) closes.
- Power passes to and energizes supply starter relay (RF).
- Power passes to normally open fan contact (RF), which is energized and closed. Power reaches and energizes supply fan. The recirculation damper is closed.
- When the recirculation contact (S3) is closed, the recirculation damper is opened to allow recirculated air to enter the unit and mix with the heated outside air.

### Potentiometer Recirculation Control

- Power passes to inlet damper which opens.
- When damper is fully opened, normally open damper limit switch (DL1) closes.
- Power passes to and energizes supply starter relay (RF).
- Power passes to normally open fan contact (RF), which is energized and closed. Power reaches and energizes supply fan.
- The potentiometer will output a 2-10 VDC signal to the recirculation damper actuator to control recirculation damper position.

### External Signal Recirculation

- Power passes to inlet damper which opens.
- When damper is fully opened, normally open damper limit switch (DL1) closes.
- Power passes to and energizes supply starter relay (RF).
- Power passes to normally open fan contact (RF), which is energized and closed. Power reaches and energizes supply fan.
- An external source will provide a 2-10 VDC or 4-20 mA signal to the recirculation damper actuator to control recirculation damper position.

### Building Pressure Recirculation Control

- Power passes to inlet damper which opens.
- When damper is fully opened, normally open damper limit switch (DL1) closes.
- Power passes to and energizes supply starter relay (RF).
- Power passes to normally open fan contact (RF), which is energized and closed. Power reaches and energizes supply fan.
- The photohelic building pressure controller will monitor the pressure differential between the pressure in the controlled space and the pressure outside the controlled space.
- If the pressure differential is below the set point range established on the photohelic controller, the recirculation damper will be modulated further closed.
- If the pressure differential is above the set point range established on the photohelic controller, the recirculation damper will be modulated further open.
- If the pressure differential is within the set point range established on the photohelic controller, the recirculation damper will remain in its current position.

## Sequence of Operation

### OPTIONAL NIGHT SETBACK

#### Night Setback Schedule

- The night setback schedule is established within the programmable thermostat on the remote panel. The schedule must be set for the occupied and unoccupied hours of the controlled space.

#### Night Setback Fan Control

- During occupied hours, the fan sequence of operation is the same as that described in the “Supply Fan” section.
- During unoccupied hours the fan is turned off.
- If there is a call for heating from the space thermostat, the fan will be turned on to allow for tempering operation.
- When the call for heating from the space thermostat ends, the fan will be turned off.

#### Night Setback Heat Control

- During occupied hours, the heating sequence of operation is the same as that described in the “Heat” sections.
- During unoccupied hours, the unit is off until there is a call for heating from the space thermostat. When the unit is enabled by a call for heat from the space thermostat, the heat is also enabled and the discharge temperature overridden to a maximum value to provide the maximum amount of heat to the space.
- When the call for heating from the space thermostat ends, the unit will be turned off.

#### Night Setback Variable Volume Control

- During occupied hours, the variable volume sequence of operation is the same as that described in the “Optional Variable Volume” section.
- During unoccupied hours, the unit is off until there is a call for heating from the space thermostat. When the unit is enabled by a call for heat from the space thermostat, the supply fan will run at minimum speed.
- When the call for heating from the space thermostat ends, the unit will be turned off.

#### Night Setback Recirculation Control

- During occupied hours, the recirculation sequence of operation is the same as that described in the “Optional Recirculation” section.
- During unoccupied hours, the unit is off until there is a call for heating from the space thermostat. When the unit is enabled by a call for heat from the space thermostat, the recirculation damper will be opened to provide a maximum amount of recirculated air to the unit.
- When the call for heating from the space thermostat ends, the unit will be turned off.



# Maintenance

## General

### CAUTION

Lock-out the gas and the electrical power to the unit before performing any maintenance or service operations to this unit.

### V-Belt Drives (if applicable)

V-belt drives must be checked on a regular basis for wear, tension, alignment, and dirt accumulation.

Check the tension by measuring the deflection in the belt as shown.

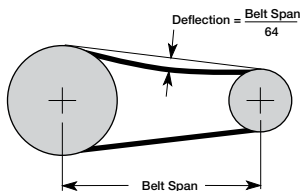

**Belt Tension**

Check the alignment by using a straight edge across both sheaves. Differences in sheave width must be accounted for.

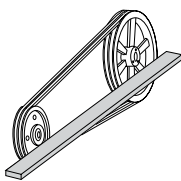

**Drive Alignment**

Premature or frequent belt failures can be caused by improper belt tension, or misaligned sheaves.

- Abnormally high belt tension or drive misalignment will cause excessive bearing loads and may result in failure of the fan and/or motor bearings.
- Abnormally low belt tension will cause excessive squealing on start-up, excessive belt flutter, slippage, and overheated sheaves.

Do not pry belts on or off the sheave. Loosen belt tension until belts can be removed by simply lifting the belts off the sheaves.

When replacing V-belts on multiple groove drives, all belts should be changed to provide uniform drive loading.

Do not install new belts on worn sheaves. If the sheaves have grooves worn in them, they must be replaced before new belts are installed.

### Snow Accumulation

Clear snow away from roof mounted units. Keep the snow clear of the intake and access doors.

### Supply Wheels

Supply wheels require little attention when moving clean air. Occasionally oil and dust may accumulate on the wheel causing imbalance. When this occurs, the wheel and housing should be cleaned to assure proper operation.

### Bearings (if applicable)

Fan bearings are carefully selected to match the maximum load and operating conditions of the specific class, arrangement and fan size. The instructions provided in this manual and those provided by the bearing manufacturer will minimize any bearing problems.

Lubricate bearings prior to periods of extended shutdowns or storage and rotate shaft monthly to aid in corrosion prevention. If the fan is stored more than three months, purge the bearings with new grease prior to start-up.

Recommended Bearing Lubrication Schedule (in months*)					
Fan RPM	Bearing Bore Size (inches)				
	1/2 - 1	1 1/8 - 1 1/2	1 5/8 - 1 7/8	1 15/16 - 2 3/16	2 7/16 - 3
250	6	6	6	6	6
500	6	6	6	5	4
750	6	5	4	3	3
1000	5	3	2	1	1
1250	5	3	2	1	1
1500	5	2	1	1	0.5
2000	5	1	1	0.5	0.25

\*Suggested initial greasing interval is based on 12 hour per day operation and 150°F (48.9°C) maximum housing temperature. For continuous (24 hour) operation, decrease greasing interval by 50%

- If extended grease lines are present, relubricate while in operation, only without endangering personnel.
- For ball bearings (operating) relubricate until clean grease is seen purging at the seals. Be sure not to unseat the seal by over lubricating.
- For ball bearings (idle) add 1-2 shots of grease up to 2 inch bore size, and 4-5 shots above 2 inch bore sizes with a hand grease gun.
- For roller bearings add 4 shots of grease up to 2 inch bore size, and 8 shots for 2-5 inch bore size with a hand grease gun.
- Adjust relubrication frequency based on condition of purged grease.
- A high quality lithium based grease conforming to NLGI Grade 2 consistency, such as those listed here:

Mobil 532	Texaco Multifak #2	B Shell Alavania #2
Mobilux #2	Texaco Premium #2	Exxon Unirex #2

# Maintenance

## General

### Motors

Motor maintenance is generally limited to cleaning and lubrication (where applicable).

Limit cleaning to exterior surfaces only. Removing dust and grease build-up on the motor assures proper motor cooling.

Grease motors supplied with grease fittings in accordance with the manufacturer's recommendations.

Do not allow water or solvents to enter the motor or bearings. Never spray motors and bearings with steam, water or solvents.

Greasing motors is only intended when fittings are provided. Many motors are permanently lubricated, requiring no additional lubrication.

### Filters

Filter maintenance is generally limited to cleaning and replacement.

If aluminum mesh filters are installed, they can be washed in warm soapy water.

An adhesive spray can be added to aluminum mesh filters to increase their efficiency.

If disposable filters are installed, they can be checked by holding up to a light source. If light cannot pass through the filter, it must be replaced.

When reinstalling filters, be sure to install them with the airflow in the correct direction. An airflow direction arrow is located on the side of the filters.

Replacement filters must be from the same manufacturer and the same size as the original filters provided with the unit.

### Chilled Water Coils

Test the circulating fluid for sediment, corrosive products and biological contaminants. Take the necessary corrective measures.

Maintain adequate fluid velocities and proper filtering of the fluid.

If automatic air vents are not utilized, periodic venting of the coil is recommended to remove accumulated air.

### Evaporative Cooling Module

The media must periodically be brushed lightly with a soft bristle brush in an up and down motion while flushing with water. This aids in reducing the amount of mineral build-up.

For large amounts of mineral build-up, clean or replace the media and increase the water bleed-off or drain and fill rate.

The cooling media has a useful life of 3 to 5 years depending on the water quality and the bleed-off or drain and fill rate.

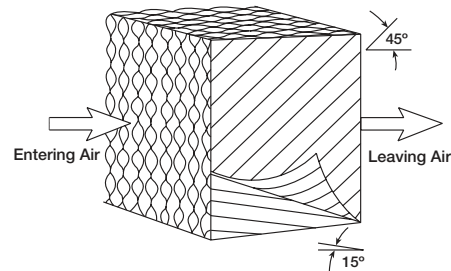

**Media Orientation**

When reinstalling the evaporative media, make sure that it is installed correctly.

Replacement media must be from the same manufacturer and be the same size as the original media provided with the unit.

### Cooling Coils

Repair and replacement of the coil and the connecting piping, valves, etc., must be performed by a qualified individual.

Inspect the coil for signs of corrosion and/or leaks. Repair any leaks as required.

Inspect the coil's surface for foreign material. If the coil surface needs cleaning, clean the coil from the leaving air-side so that foreign material will be washed out of the coil rather than pushed farther in.

Inspect and clean the drain pan to prevent the growth of algae and other organisms.

Be sure to read and follow the coil manufacturer's recommendations before using any cleaning fluid.

Caution must be used to avoid injury when venting the coil. High pressure and/or high temperature fluids can cause serious injuries.



### Start-Up

---

Repeat *Supply Fan, Pre-Start Checks and Start-Up; Pre-Start: Direct Gas-Fired Heating; and Start-Up: Direct Gas-Fired Heating* sections in this Installation, Operation and Maintenance Manual. This will ensure that the gas and air are set properly before the heating season begins and should lead to trouble free operation all winter.

### High Limit

---

The high limit switch may have tripped over the summer; check and reset if necessary.

### Burner

---

Inspect the burner for accumulation of scale on both the upstream and downstream sides of the mixing plates. Remove foreign material with a wire brush.

Visually check that all holes in the mixing plates are clear. If any burner ports are plugged (even partially), clear them with a piece of wire or another appropriate tool. Do not enlarge burner ports when clearing a blockage as performance could be affected.

Replace or tighten any loose or missing fasteners on the mixing plates. Always use appropriate fasteners.

Inspect and clean the flame rod or UV scanner. Occasional replacement of the flame rod and spark rod may be necessary to ensure optimum unit performance.

### Gas Train

---

Check the gas connections, joints and valves annually for tightness. Apply a soap and water solution to all piping; watch for bubbling which indicates a leak.

### Evaporative Cooling Module

---

Shut off the water and drain all exposed lines when the outside temperature drops below 45°F (7.2°C).

Clean all interior parts of any mineral deposits or foreign materials that may have built-up during the cooling season.

Replace any worn or non-functioning parts.

### Winterizing Chilled Water Coils

---

During the winter, chilled water coils must be protected against freezing. Manufacturer recommends draining the coils.

# Troubleshooting

## Supply Fan

### Problem: Fan does not operate.

Line voltage across L1 & L2, L2 & L3, and L1 & L3 on main disconnect (DS1)?	Yes ↓	No →	<b>Main incoming power not connected.</b> Connect proper supply power to unit.
Line voltage across T1 & T2, T2 & T3, and T1 & T3 on main disconnect (DS1)	Yes ↓	No →	<b>Main disconnect (DS1) open or defective.</b> Close, repair, or replace.
24 VAC across R and C?	Yes ↓	No →	<b>Main transformer (TR1) circuit breaker tripped.</b> Reset transformer circuit breaker. If circuit breaker continues to trip, inspect circuit for improper wiring or grounding. <b>Main transformer (TR1) failed.</b> Replace main transformer. <b>Phase monitor (PM) contact open.</b> Correct incoming phase order at disconnect. <b>Fuse (FU6) blown.</b> Test and replace blown fuse(s).
24 VAC across G and C?	Yes ↓	No →	<b>Fan switch (S2) open or not wired.</b> Close or wire fan switch. <b>Fire system contact (FSC) tripped/not installed.</b> Correct or replace. <i>If fan switch and fire system contact is not required, place jumper from R to G to make the fan run continuously.</i>
24 VAC across A2 and A1 on the RF relay?	Yes ↓	No →	<b>Freeze protection tripped.</b> Cycle disconnect to reset. <b>Supply fan overload tripped.</b> Push reset button on overload or VFD to reset. Check motor amp draw and correct as necessary. <b>Damper limit switch (D1L) not closed.</b> <b>Damper stuck closed or actuator failed.</b> Repair damper interference or replace actuator. <b>Exhaust fan contactor not powered.</b> Close or wire exhaust switch, reset exhaust overload, or replace faulty exhaust contactor.
24 VAC across A2 and A1 on the supply contactor (ST1)?	Yes ↓	No →	<b>RF relay failure.</b> Check for loose connection or bent relay pins, repair or replace relay.
Line voltage across L1 & L2, L2 & L3, and L1 & L3 on supply starter (ST1)?	Yes ↓	No →	<b>Supply motor fuse (FU1) blown.</b> Test and replace blown fuse(s).
Line voltage across T1 & T2, T2 & T3, and T1 & T3 on supply starter (ST1)?	Yes ↓	No →	<b>Supply starter contact (ST1) not closed.</b> Replace contactor.
Line voltage across T1 & T2, T2 & T3, and T1 & T3 on supply starter overload (ST1OL)?	Yes ↓	No →	<b>Supply overload (ST1OL) faulty.</b> Replace overload.
Is motor operating?	Yes ↓	No →	<b>Motor wired incorrectly.</b> Check and correct motor wiring. <b>Defective motor/capacitor.</b> Repair or replace.
Is the fan operating?	Yes ↓	No →	<b>Broken fan belt.</b> Replace. Reference Maintenance, General, V-Belt Drives.
Everything is working properly, consult factory.			

### Problem: Too much airflow.

Fan speed too high?	No ↓	Yes →	<b>Adjust drives or VFD as needed.</b> Reference Supply Fan, Start-Up.
Filters in place?	Yes ↓	No →	<b>Install filters.</b>
Insufficient external static pressure?		Yes →	<b>Increase external static pressure.</b>
Everything is working properly, consult factory.			





# Troubleshooting

## Supply Fan

### Problem: Motor overamps.

Motor voltage correct?	Yes ↓	No →	Provide proper power supply. Reference Supply Fan, Start-Up.
Fan rotation correct?	Yes ↓	No →	Reverse fan rotation. Reference Supply Fan, Start-Up.
Air volume too high?	No ↓	Yes →	Adjust drives or increase external static pressure as needed. Reference Supply Fan, Start-Up.
Actual static pressure lower than design?	No ↓	Yes →	Adjust drives to reduce fan RPM. Reference Supply Fan, Start-Up.
All three phases supplied to motor?	Yes ↓	No →	Supply motor fuse (FU1) blown. Test and replace blown fuse(s).
Motor horsepower too low?	No ↓	Yes →	Resize motor.
Shorted windings in motor?		Yes →	Replace motor.

Everything is working properly, consult factory.

### Problem: Insufficient airflow.

Damper(s) not fully opened?	No ↓	Yes →	Adjust damper linkage(s), or replace faulty actuator(s). Damper actuators may take a few minutes to open.
Fan rotation correct?	Yes ↓	No →	Reverse fan rotation. Reference Supply Fan, Start-Up.
Filters dirty or clogged?	No ↓	Yes →	Clean or replace filters. Reference Maintenance, General, Filters.
Belt slipping or broken?	No ↓	Yes →	Replace or tighten belt. Reference Maintenance, General, V-Belt Drives.
Fan speed too low?	No ↓	Yes →	Adjust drives as needed. Reference Supply Fan, Start-Up section.
System static losses too high?	No ↓	Yes →	Reduce losses by improving ductwork.
Leaks in ductwork?		Yes →	Repair leaks.

Everything is working properly, consult factory.

### Problem: Excessive noise or vibration.

Belts worn or loose?	No ↓	Yes →	Replace worn belts or tighten loose belts. Reference Maintenance, General, V-Belt.
Sheaves aligned?	Yes ↓	No →	Align sheaves. Reference Maintenance, General, V-Belt Drives.
Wheel(s) unbalanced?	No ↓	Yes →	Clean and/or balance wheel(s).
Bearings worn or need lubrication?	No ↓	Yes →	Replace worn bearings or lubricate bearings as needed. Reference Maintenance, General, Bearings.
Wheel(s) rubbing on inlet?	No ↓	Yes →	Adjust wheel(s) or inlet.
Fan rotation correct?	Yes ↓	No →	Reverse fan rotation. Reference Supply Fan, Start-Up.

Everything is working properly, consult factory.

# Troubleshooting

## Direct Gas-Fired Heat

### Problem: Heater does not operate (120V industrial pilot: >18-inch burner).

Is fan operating correctly?	Yes ↓	No →	<b>Refer to Troubleshooting, Supply Fan.</b>
24 VAC between terminals W1 and C?	Yes ↓	No →	<b>Heat switch (S4) off.</b> Turn heat switch (S4) on. <b>Heat switch not wired.</b> Wire heat switch (S4). <i>If a heat switch is not required and a heating inlet air sensor is provided, place jumper from R to W1 to allow the heat to enable based on the heating inlet air sensor.</i>
24 VAC between A2 and A1 on RH relay?	Yes ↓	No →	<b>(Optional) inlet air sensor (TS4) holding.</b> Adjust TS4 setting. Reference Supply Fan, Start-Up. <b>Fan interlock (ST1 or RF) open.</b> Refer to Troubleshooting, Supply Fan.
Line voltage at primary side of TR3?	Yes ↓	No →	<b>Transformer fuses (FU7) blown.</b> Check and replace blown fuse(s).
115 VAC between terminals 102 and 101?	Yes ↓	No →	<b>Transformer secondary fuses (FU8) blown.</b> Check and replace blown fuse(s). <b>Transformer TR3 wired incorrectly.</b> Refer to wiring diagram on transformer and correct wiring. <b>Transformer TR3 faulty.</b> Replace transformer.
115 VAC between terminals 103 and 101?	Yes ↓	No →	<b>Heat relay (RH) failure.</b> Check for loose connections or bent relay pins, repair or replace relay.
Does power light on the flame safeguard blink approximately every 5 seconds as it performs a self-diagnostics check?	Yes ↓	No →	<b>Check wiring in flame safeguard subbase.</b> Correct any wiring issues. <b>Flame safeguard (FSG) faulty.</b> Replace flame safeguard.
115 VAC between terminals 104 and 101?	Yes ↓	No →	<b>High limit (HLC1) tripped.</b> Reset/replace high limit (HLC1). Investigate cause of high limit trip.
115 VAC between terminals 106 and 101?	Yes ↓	No →	<b>(Optional) high/low gas pressure switch(es) (PS3 and PS4) tripped.</b> Correct gas pressure and reset. Reference Pre-Start: Direct Gas-Fired Heating, All Units.
Is alarm light blinking on the flame safeguard (FSG)?	No ↓	Yes →	<b>Record the flash code from the alarm light.</b> Reference the flame safeguard literature or contact the factory for details about the alarm flash codes. Investigate the cause of the code. <b>Push the reset button to reset the fault.</b>
Is test/run switch (located on top of flame safeguard) in 'Run' mode?	Yes ↓	No →	<b>Move switch to 'Run'.</b>
115 VAC between terminals 107 and 101?	Yes ↓	No →	<b>Check wiring in flame safeguard subbase.</b> Correct any wiring issues. <b>Flame safeguard (FSG) faulty.</b> Replace flame safeguard.
115 VAC between terminals 108 and 101?	Yes ↓	No →	<b>Airflow switch (PS2) holding for proper airflow.</b> Correct airflow across burner. Reference Start-Up: Direct Gas-Fired Heating, All Units.
Is the pilot light on the flame safeguard (FSG) illuminated?	Yes ↓	No →	<b>Check wiring in flame safeguard subbase.</b> Correct any wiring issues. <b>Flame safeguard (FSG) faulty.</b> Replace flame safeguard.
115 VAC between terminals 109 and 101?	Yes ↓	No →	<b>Check wiring in flame safeguard subbase.</b> Correct any wiring issues. <b>Flame safeguard (FSG) faulty.</b> Replace flame safeguard
Pilot flame visible through sight glass?	No ↓	Yes →	<b>A</b> <i>Skip to question that reads, <b>Red flame light on flame safeguard (FSG) illuminated?</b></i>
Inlet gas pressure between the minimum and maximum values shown on the direct gas label?	Yes ↓	No →	<b>Correct the inlet gas pressure.</b>



# Troubleshooting

## Direct Gas-Fired Heat

Pressure drop across the burner between 0.625 - 0.675 in. wg for natural gas (0.8 - 0.9 in. wg for LP gas)?	Yes ↓	No →	<b>Adjust fan speed and/or burner baffles to achieve 0.625 - 0.675 in. wg for natural gas (0.8 - 0.9 in.wg for LP gas) pressure drop.</b>
Air in the gas line?	No ↓	Yes →	<b>Purge the gas line.</b>
Pilot gas valve passing gas pressure to pilot gas pressure test port?	Yes ↓	No →	<b>Pilot gas valve (PV) faulty.</b> Replace pilot gas valve.
Pilot gas pressure set correctly?	Yes ↓	No →	<b>Set pilot gas pressure to recommended value.</b>
Is a spark visible or audible during the trial for ignition?	Yes ↓	No →	<b>Spark and flame wires crossed.</b> Uncross wires and reconnect. <b>Incorrect spark plug gap.</b> Set spark plug gap to 0.062 in. <b>Defective spark plug.</b> Replace spark plug. <b>Spark generator faulty.</b> Replace spark generator.
At this time, the pilot flame should light.			
<b>A</b> Red flame light on flame safeguard (FSG) illuminated?	No ↓	Yes →	<b>B</b> Skip to question that reads, <b>Yellow main light on flame safeguard (FSG) illuminated?</b>
Flame rod dirty or corroded?	No ↓	Yes →	<b>Clean flame rod.</b> Remove corrosion with emery cloth. <b>Replace flame rod.</b>
Electrical continuity from control center end of flame wire to flame rod boot?	Yes ↓	No →	<b>Flame wire broken.</b> Replace wire. <b>Connection at flame rod boot failed.</b> Repair connection. <b>Flame rod boot corroded.</b> Replace flame rod boot.
Electrical continuity from flame wire to ground?	No ↓	Yes →	<b>Shield or spare wire touching flame wire in flame rod boot.</b> Cut shield or spare wire back to eliminate contact. <b>Burr from flame rod threads touching flame rod.</b> Remove burr.
Flame rod or flame rod porcelain cracked or deteriorated?	No ↓	Yes →	<b>Replace flame rod.</b>
120 VAC or more on terminal 'S' on flame safeguard amplifier?	Yes ↓	No →	<b>Check wiring in flame safeguard subbase.</b> Correct any wiring issues. <b>Flame safeguard (FSG) or flame safeguard amplifier faulty.</b> Replace flame safeguard or flame safeguard amplifier.
1.25 VDC or higher on terminals [+] & [-] on flame safeguard amplifier?	Yes ↓	No →	<b>Pilot pressure too low.</b> Increase pilot pressure. <b>Check wiring in flame safeguard subbase.</b> Correct any wiring issues. <b>Flame safeguard (FSG) or flame safeguard amplifier faulty.</b> Replace flame safeguard or flame safeguard amplifier.
With a flame signal of 1.25 VDC or higher, the red flame light on the flame safeguard should be illuminated.			
<b>B</b> Yellow main light on flame safeguard (FSG) illuminated?	Yes ↓	No →	<b>Check wiring in flame safeguard subbase.</b> Correct any wiring issues. <b>Flame safeguard (FSG) faulty.</b> Replace flame safeguard.
115 VAC between terminals 110 and 101?	Yes ↓	No →	<b>Check wiring in flame safeguard subbase.</b> Correct any wiring issues. <b>Flame safeguard (FSG) faulty.</b> Replace flame safeguard.
Gas pressure at outlet of the first solenoid valve?	Yes ↓	No →	<b>Inlet gas pressure too high.</b> Reduce inlet gas pressure to below the maximum gas pressure. <b>Solenoid valve stuck shut.</b> Tap valve gently to loosen. <b>Solenoid failed.</b> Replace solenoid or valve assembly.
Gas pressure at outlet of second solenoid valve?	Yes ↓	No →	<b>Solenoid valve stuck shut.</b> Tap valve gently to loosen. <b>Solenoid failed.</b> Replace solenoid or valve assembly.
Main burner flame lit?	Yes ↓	No →	<b>Low fire set too low.</b> Adjust low fire as described in the burner startup section.
Everything is working properly, consult factory.			

# Troubleshooting

## Direct Gas-Fired Heat

### Problem: Heater does not operate (120V commercial pilot: >18-inch burner).

Is fan operating correctly?	Yes ↓	No →	<b>Refer to Troubleshooting, Supply Fan.</b>
24 VAC between terminals W1 and C?	Yes ↓	No →	<b>Heat switch (S4) off.</b> Turn heat switch (S4) on. <b>Heat switch not wired.</b> Wire heat switch (S4). <i>If a heat switch is not required and a heating inlet air sensor is provided, place jumper from R to W1 to allow the heat to enable based on the heating inlet air sensor.</i>
24 VAC between A2 and A1 on RH relay?	Yes ↓	No →	<b>(Optional) inlet air sensor (TS4) holding.</b> Adjust TS4 setting. Reference Supply Fan, Start-Up. <b>Fan interlock (ST1 or RF) open.</b> Refer to Troubleshooting, Supply Fan.
Line voltage at primary side of TR3?	Yes ↓	No →	<b>Transformer fuses (FU7) blown.</b> Check and replace blown fuse(s).
115 VAC between terminals 102 and 101?	Yes ↓	No →	<b>Transformer secondary fuses (FU8) blown.</b> Check and replace blown fuse(s). <b>Transformer TR3 wired incorrectly.</b> Refer to wiring diagram on transformer and correct wiring. <b>Transformer TR3 faulty.</b> Replace transformer.
115 VAC between terminals 103 and 101?	Yes ↓	No →	<b>Heat relay (RH) failure.</b> Check for loose connections or bent relay pins, repair or replace relay.
115 VAC between terminals 104 and 101?	Yes ↓	No →	<b>High limit (HLC1) tripped.</b> Reset/replace high limit (HLC1). Investigate cause of high limit trip.
115 VAC between terminals 106 and 101?	Yes ↓	No →	<b>(Optional) High/low gas pressure switch(es) (PS3 and PS4) tripped.</b> Correct gas pressure and reset. Reference Start-Up: Direct Gas-Fired Heating.
115 VAC between terminals 107 and 101?	Yes ↓	No →	<b>Airflow switch (PS2) holding for proper airflow.</b> Correct airflow across burner. Reference Pre-Start: Direct Gas-Fired Heating, All Units.
Green light flashing or illuminated on flame safeguard?	Yes ↓	No →	<b>Check wiring to flame safeguard.</b> Correct any wiring issues. <b>Flame safeguard (FSG) faulty.</b> Replace flame safeguard.
115 VAC between terminals 109 and 101?	Yes ↓	No →	<b>Check wiring to flame safeguard.</b> Correct any wiring issues. <b>Flame safeguard (FSG) faulty.</b> Replace flame safeguard.
Pilot flame visible through sight glass?	Yes ↓	No →	<b>C</b> <i>Skip to question that reads, <b>Steady green light illuminated on flame safeguard (FSG)?</b></i>
Inlet gas pressure between the minimum and maximum values shown on the direct gas label?	Yes ↓	No →	<b>Correct the inlet gas pressure.</b>
Pressure drop across the burner between 0.625 - 0.675 in. wg for natural gas (0.8 - 0.9 in. wg for LP gas)?	Yes ↓	No →	<b>Adjust fan speed and/or burner baffles to achieve 0.625 - 0.675 in. wg for natural gas (0.8 - 0.9 in. wg for LP gas) pressure drop.</b>
Air in the gas line?	No ↓	Yes →	<b>Purge the gas line.</b>
Pilot gas valve passing gas pressure to pilot gas pressure test port?	Yes ↓	No →	<b>Check wiring to pilot gas valve (PV).</b> Correct any wiring issues. <b>Pilot gas valve (PV) faulty.</b> Replace pilot gas valve.
Pilot gas pressure set correctly?	Yes ↓	No →	<b>Set pilot gas pressure to recommended value.</b>
Is a spark visible or audible during the trial for ignition?	Yes ↓	No →	<b>Spark and flame wires crossed.</b> Uncross wires and reconnect. <b>Incorrect spark plug gap.</b> Set spark plug gap to 0.062 in. <b>Defective spark plug.</b> Replace spark plug. <b>Spark generator faulty.</b> Replace spark generator.

At this time, the pilot flame should light.



# Troubleshooting

## Direct Gas-Fired Heat

<b>C</b> Steady green light illuminated on flame safeguard (FSG)?	No ↓	Yes →	<b>D</b> Skip to question that reads, <b>115 VAC between terminals 110 and 101?</b>
Flame rod dirty or corroded?	No ↓	Yes →	<b>Clean flame rod.</b> Remove corrosion with emery cloth.
Electrical continuity from control center end of flame wire to flame rod boot?	Yes ↓	No →	<b>Flame wire broken.</b> Replace wire. <b>Connection at flame rod boot failed.</b> Repair connection. <b>Flame rod boot corroded.</b> Replace flame rod boot.
Electrical continuity from flame wire to ground?	No ↓	Yes →	<b>Shield or spare wire touching flame wire in flame rod boot.</b> Cut shield or spare wire back to eliminate contact. <b>Burr from flame rod threads touching flame rod.</b> Remove burr.
Flame rod or flame rod porcelain cracked or deteriorated?	No ↓	Yes →	<b>Clean flame rod.</b> Remove corrosion with emery cloth. <b>Replace flame rod.</b>
1.0 micro amps or higher on terminals FC '+' and '-' on flame safeguard amp?	Yes ↓	No →	<b>Pilot pressure too low.</b> Increase pilot pressure. <b>Check wiring to flame safeguard.</b> Correct any wiring issues. <b>Flame safeguard (FSG) or flame safeguard amplifier faulty.</b> Replace flame safeguard.

With a flame signal of 1.0 micro amps or higher, the green flame light should be illuminated and steady.

<b>D</b> 115 VAC between terminals 110 and 101?	Yes ↓	No →	<b>Check wiring to flame safeguard.</b> Correct any wiring issues. <b>Flame safeguard (FSG) faulty.</b> Replace flame safeguard.
Gas pressure at outlet of the first solenoid valve?	Yes ↓	No →	<b>Inlet gas pressure too high.</b> Reduce inlet gas pressure to below the maximum gas pressure. <b>Solenoid valve stuck shut.</b> Tap valve gently to loosen. <b>Solenoid failed.</b> Replace solenoid or valve assembly.
Gas pressure at outlet of second solenoid valve?	Yes ↓	No →	<b>Solenoid valve stuck shut.</b> Tap valve gently to loosen. <b>Solenoid failed.</b> Replace solenoid or valve assembly.
Main burner flame lit?	Yes ↓	No →	<b>Low fire set too low.</b> Adjust low fire as described in the burner startup section.

Everything is working properly, consult factory.

### Problem: Heater does not operate (24V commercial pilot: <=18-inch burner).

Is fan operating correctly?	Yes ↓	No →	<b>Refer to Troubleshooting, Supply Fan.</b>
24 VAC between terminals W1 and C?	Yes ↓	No →	<b>Heat switch (S4) off.</b> Turn heat switch (S4) on. <b>Heat switch not wired.</b> Wire heat switch (S4). <i>If a heat switch is not required and a heating inlet air sensor is provided, place jumper from R to W1 to allow the heat to enable based on the heating inlet air sensor.</i>
24 VAC between A2 and A1 on RH relay?	Yes ↓	No →	<b>(Optional) inlet air sensor (TS4) holding.</b> Adjust TS4 setting. Reference Start-Up: Optional Features, Other, Heating and/or Cooling Inlet Air Sensor(s) <b>Fan interlock (ST1 or RF) open.</b> Refer to Troubleshooting, Supply Fan.
24 VAC between terminals 22 and 21?	Yes ↓	No →	<b>Transformer TR3 faulty.</b> Replace transformer.
24 VAC between terminals 23 and 21?	Yes ↓	No →	<b>Heat relay (RH) failure.</b> Check for loose connections or bent relay pins, repair or replace relay.
24 VAC between terminals 24 and 21?	Yes ↓	No →	<b>High limit (HLC1) tripped.</b> Reset/replace high limit (HLC1). Investigate cause of high limit trip.
24 VAC between terminals 26 and 21?	Yes ↓	No →	<b>(Optional) high/low gas pressure switch(es) (PS3 and PS4) tripped.</b> Correct gas pressure and reset. Reference Pre-Start: Direct Gas-Fired Heating, All Units.

# Troubleshooting

## Direct Gas-Fired Heat

24 VAC between terminals 27 and 21?	Yes ↓	No →	<b>Airflow switch (PS2) holding for proper airflow.</b> Correct airflow across burner. Reference Pre-Start: Direct Gas-Fired Heating, All Units.
Pilot flame visible through sight glass?	No ↓	Yes →	<b>E</b> Skip to question that reads, <b>Steady green light illuminated on flame safeguard (FSG)?</b>
Inlet gas pressure between the minimum and maximum values shown on the direct gas label?	Yes ↓	No →	<b>Correct the inlet gas pressure.</b>
Pressure drop across the burner between 0.625 - 0.675 in. wg for natural gas (0.8 - 0.9 in.wg for LP gas)?	Yes ↓	No →	<b>Adjust fan speed and/or burner baffles to achieve 0.625 - 0.675 in. wg for natural gas (0.8 - 0.9 in.wg for LP gas) pressure drop.</b>
Air in the gas line?	No ↓	Yes →	<b>Purge the gas line.</b>
Pilot gas valve passing gas pressure to pilot gas pressure test port? <i>Skip this step if no pilot test port is present.</i>	Yes ↓	No →	<b>Pilot gas valve (PV) faulty.</b> Replace pilot gas valve.
Pilot gas pressure set correctly? <i>Skip this step if no pilot test port is present</i>	Yes ↓	No →	<b>Set pilot gas pressure to recommended value.</b>
Is a spark visible or audible during the trial for ignition?	Yes ↓	No →	<b>Spark and flame wires crossed.</b> Uncross wires and reconnect. <b>Incorrect spark plug gap.</b> Set spark plug gap to 0.062 in. <b>Defective spark plug.</b> Replace spark plug. <b>Spark generator faulty.</b> Replace spark generator.
At this time, the pilot flame should light.			
<b>E</b> Steady green light illuminated on flame safeguard (FSG)?	Yes ↓	No →	<b>F</b> Skip to question that reads, <b>24 VAC between terminals 37 and 21?</b>
Flame rod dirty or corroded?	Yes ↓	No →	<b>Clean flame rod.</b> Remove corrosion with emery cloth.
Electrical continuity from control center end of flame wire to flame rod boot?	Yes ↓	No →	<b>Flame wire broken.</b> Replace wire. <b>Connection at flame rod boot failed.</b> Repair connection. <b>Flame rod boot corroded.</b> Replace flame rod boot.
Electrical continuity from flame wire to ground?	No ↓	Yes →	<b>Shield or spare wire touching flame wire in flame rod boot.</b> Cut shield or spare wire back to eliminate contact. <b>Burr from flame rod threads touching flame rod.</b> Remove burr.
Flame rod or flame rod porcelain cracked or deteriorated?	No ↓	Yes →	<b>Replace flame rod.</b>
1.0 micro amps or higher on terminals FC '+' and '-' on flame safeguard amp?	Yes ↓	No →	<b>Pilot pressure too low.</b> Increase pilot pressure. <b>Check wiring to flame safeguard.</b> Correct any wiring Issues. <b>Flame safeguard (FSG) or flame safeguard amplifier faulty.</b> Replace flame safeguard.
With a flame signal of 1.0 micro amps or higher, the green flame light should be illuminated and steady.			
<b>F</b> 24 VAC between terminals 37 and 21?	Yes ↓	No →	<b>Check wiring to flame safeguard.</b> Correct any wiring issues. <b>Flame safeguard (FSG) faulty.</b> Replace flame safeguard.
Gas pressure at outlet of the first solenoid valve?	Yes ↓	No →	<b>Inlet gas pressure too high.</b> Reduce inlet gas pressure to below the maximum gas pressure. <b>Solenoid valve stuck shut.</b> Tap valve gently to loosen. <b>Solenoid failed.</b> Replace solenoid or valve assembly.
Main burner flame lit?	Yes ↓	No →	<b>Low fire set too low.</b> Adjust low fire as described in the burner startup section.
Everything is working properly, consult factory.			



# Troubleshooting

## Direct Gas-Fired Heat

### Problem: Heater does not modulate correctly. Maxitrol 14 Series system.

Is fan operating correctly?	Yes ↓	No →	Refer to Troubleshooting, Supply Fan.
Is the burner operating and lit?	Yes ↓	No →	Refer to Troubleshooting, Direct Gas-Fired Heat.
24 VAC at terminals 38 and 39?	Yes ↓	No →	<b>Transformer TR6 faulty.</b> Replace transformer.
Remove the wire from terminal 3 on the Maxitrol Amplifier (AMP). 24 VDC to modulating valve (MOD)?	Yes ↓	No →	<b>Amplifier (AMP) faulty.</b> Replace amplifier
Burner operating at high fire?	Yes ↓	No →	<b>High fire adjustment not set correctly.</b> Adjust high fire setting. Reference Start-Up: Direct Gas-Fired Heating, Industrial or Commercial Pilot Systems. <b>Inlet gas pressure too low to provide high fire.</b> Increase inlet gas pressure to above the minimum input for maximum output value. <b>Modulating valve (MOD) stuck.</b> Tap valve gently to loosen <b>Modulating valve (MOD) faulty.</b> Replace modulating valve.
Reconnect wire to Terminal 3. Remote dial connected to terminals 1 and 2 on the Maxitrol Amplifier (AMP)?	Yes ↓	No →	<b>Connect remote dial.</b> <i>If a remote dial is not required, set the Selector DIP switch to Integral to allow the onboard set point to control the discharge temperature. If this is set to Integral.</i>
Is the 'Selector' DIP switch set to 'Remote'?	Yes ↓	No →	<b>Set the 'Selector' DIP switch to 'Remote' to allow the remote dial to control the discharge temperature.</b>
Is the 'LFST' switch set to '10 Sec'?	Yes ↓	No →	<b>Set the 'LFST' DIP switch to '10 Sec' to allow the main portion of the burner to ignite at low fire.</b>
Remove the wires from terminals 1 and 2 on the Maxitrol Amplifier (AMP). Check resistance between the two wires. Is the resistance in the range of 9000-13000 ohms?	Yes ↓	No →	<b>Remote temperature dial (TS3) wired incorrectly.</b> Correct wiring. <b>Remote temperature dial (TS3) faulty.</b> Replace remote temperature dial. <i>A remote temperature dial failure will usually result in a reading of infinite or zero resistance between the two wires.</i>
Remove the wires from terminals 3 and 4 on the Maxitrol Amplifier (AMP). Check resistance between the two wires. Is the resistance in the range of 5000-13000 ohms?	Yes ↓	No →	<b>Discharge temperature sensor (TS2) wired incorrectly.</b> Correct wiring. <b>Discharge temperature sensor (TS2) faulty.</b> Replace discharge temperature sensor. <i>A discharge temperature sensor failure will usually result in a reading of infinite or zero resistance between the two wires.</i>

Everything is working properly, consult factory.

### Problem: Heater does not modulate correctly. Maxitrol 44 Series system.

Is fan operating correctly?	Yes ↓	No →	Refer to Troubleshooting, Supply Fan.
Is the burner operating and lit?	Yes ↓	No →	Refer to Troubleshooting, Direct Gas-Fired Heat.
24 VAC at terminals 38 and 39?	Yes ↓	No →	<b>Transformer TR6 faulty.</b> Replace transformer.
Remove the wire from terminal 3 on the Maxitrol Amplifier (AMP). 24 VDC at terminals on modulating valve (MOD)?	Yes ↓	No →	<b>Amplifier (AMP) faulty.</b> Replace amplifier
With the wire from terminal 3 on, the Maxitrol Amplifier (AMP) removed, is the burner operating at high fire?	Yes ↓	No →	<b>High fire adjustment not set correctly.</b> Adjust high fire setting. Reference Start-Up: Direct Gas-Fired Heating, Industrial or Commercial Pilot Systems. <b>Inlet gas pressure too low to provide high fire.</b> Increase inlet gas pressure to above the minimum input for maximum output value. <b>Modulating valve (MOD) stuck.</b> Tap valve gently to loosen. <b>Modulating valve (MOD) faulty.</b> Replace modulating valve.



## Troubleshooting

### Direct Gas-Fired Heat

Reconnect wire to Terminal 3. Remote dial connected to terminals 4 and 5 on the Maxitrol Amplifier (AMP)?	Yes ↓	No →	<b>Connect remote dial.</b>
Is the 'LFST' switch set to '10 Sec'?	Yes ↓	No →	<b>Set the 'LFST' DIP switch to '10 Sec' to allow the main portion of the burner to ignite at low fire.</b>
Turn the remote dial to the setting that matches the ambient temperature where the dial is located. Remove the wires from terminals 4 and 5 on the Maxitrol Amplifier (AMP). Check resistance between the two wires. Is the resistance in the range of 5500-6500 ohms?	Yes ↓	No →	<b>Remote temperature dial (TS3) wired incorrectly.</b> Correct wiring. <b>Remote temperature dial (TS3) faulty.</b> Replace remote temperature dial. <i>A remote temperature dial failure will usually result in a reading of infinite or zero resistance between the two wires.</i>
Remove the wires from terminals 1 and 2 on the Maxitrol Amplifier (AMP). Check resistance between the two wires. Is the resistance in the range of 1000-8000 ohms?	Yes ↓	No →	<b>Discharge temperature sensor (TS2) wired incorrectly.</b> Correct wiring. <b>Discharge temperature sensor (TS2) faulty.</b> Replace discharge temperature sensor. <i>A discharge temperature sensor failure will usually result in a reading of infinite or zero resistance between the two wires.</i>
Remove the wires from terminals 2 and 3 on the Maxitrol Amplifier (AMP). Check resistance between the two wires. Is the resistance in the range of 500-6000 ohms?	Yes ↓	No →	<b>Discharge temperature sensor (TS2) wired incorrectly.</b> Correct wiring. <b>Discharge temperature sensor (TS2) faulty.</b> Replace discharge temperature sensor. <i>A discharge temperature sensor failure will usually result in a reading of infinite or zero resistance between the two wires.</i>

Everything is working properly, consult factory.

#### Problem: Heater does not modulate correctly. Maxitrol SC Series system.

Is fan operating correctly?	Yes ↓	No →	<b>Refer to Troubleshooting, Supply Fan.</b>
Is the burner operating and lit?	Yes ↓	No →	<b>Refer to Troubleshooting, Direct Gas-Fired Heat.</b>
24 VAC at terminals 38 and 39?	Yes ↓	No →	<b>Transformer TR6 faulty.</b> Replace transformer.
Remove the wire from terminal T1 and T2 on the Maxitrol Amplifier (AMP). Place a jumper wire across the terminals. 24 VDC at terminals on modulating valve (MOD)?	Yes ↓	No →	<b>Amplifier (AMP) faulty.</b> Replace amplifier
With the jumper wire installed on terminals T1 and T2 on the Maxitrol Amplifier (AMP), is the burner operating at high fire?	Yes ↓	No →	<b>High fire adjustment not set correctly.</b> Adjust high fire setting. Reference Start-Up: Direct Gas-Fired Heating, Industrial or Commercial Pilot Systems. <b>Inlet gas pressure too low to provide high fire.</b> Increase inlet gas pressure to above the minimum input for maximum output value. <b>Modulating valve (MOD) stuck.</b> Tap valve gently to loosen. <b>Modulating valve (MOD) faulty.</b> Replace modulating valve.
Reconnect wires to Terminals T1 and T2. Analog input signal connected to terminals 5 and 6?	Yes ↓	No →	<b>Connect analog signal.</b>
Is the J3 jumper set to 0V Start?	Yes ↓	No →	<b>Set the J3 jumper to 0V Start to allow the main portion of the burner to ignite at low fire.</b>
Does the signal provided to terminals 5 and 6 match the DIP switch setting?	Yes ↓	No →	<b>If a 4-20ma signal is supplied, set DIP switches to mA. If a 0-10 VDC signal is supplied, set DIP switches to Volts.</b>





## Troubleshooting

### Direct Gas-Fired Heat

Remove the wires from terminals T1 and T2 on the Maxitrol Amplifier (AMP). Check resistance between the two wires. Is the resistance in the range of 900-1300 ohms?	Yes ↓	No →	<b>Discharge temperature sensor (TS2) wired incorrectly.</b> Correct wiring. <b>Discharge temperature sensor (TS2) faulty.</b> Replace discharge temperature sensor. <i>A discharge temperature sensor failure will usually result in a reading of infinite or zero resistance between the two wires.</i>
Everything is working properly, consult factory.			

# Troubleshooting

## Evaporative Cooling

### Problem: Evaporative Cooling Module Does Not Operate - Recirculating Pump Control

Is fan operating correctly?	Yes ↓	No →	<b>Refer to Troubleshooting, Supply Fan.</b>
24 VAC between terminals Y1 and C	Yes ↓	No →	<b>Cool switch (S4) off.</b> Turn cool switch (S4) on. <b>Cool switch not wired.</b> Wire cool switch (S4). <i>If a cool switch is not required and a cooling inlet air sensor is provided, place jumper from R to Y1 to allow the cooling to enable based on the cooling inlet air sensor.</i>
24 VAC between terminal A2 and A1 on cooling relay (RC)?	Yes ↓	No →	<b>Optional inlet air sensor (TS4) holding.</b> Adjust TS4 setting. Reference Blower, Start-Up. <b>Fan Interlock (ST1 or RF) open.</b> Refer to Troubleshooting, Supply Fan.
Line voltage at primary side of TR3?	Yes ↓	No →	<b>Transformer fuses (FU7) blown.</b> Check and replace blown fuse(s).
115 VAC between terminals 102 and 101?	Yes ↓	No →	<b>Transformer secondary fuses (FU8) blown.</b> Check and replace blown fuse(s). <b>Transformer TR3 wired incorrectly.</b> Refer to wiring diagram on transformer and correct wiring. <b>Transformer TR3 faulty.</b> Replace transformer.
115 VAC between terminals 116 and 101?	Yes ↓	No →	<b>Cooling relay (RC) failure.</b> Check for loose connections or bent relay pins, repair or replace relay.
Evaporative cooling pump(s) (P1) running?	Yes ↓	No →	<b>Evaporative cooling pump(s) (P1) wired incorrectly or not wired.</b> Correct any wiring issues. <b>Evaporative cooling pump(s) (P1) faulty.</b> Replace evaporative cooling pump(s).

Everything is working properly, consult factory.

### Problem: Evaporative Cooling Module Does Not Operate - Auto Drain and Fill Control

Is fan operating correctly?	Yes ↓	No →	<b>Refer to the Troubleshooting, Supply Fan.</b>
24 VAC between terminals Y1 and C	Yes ↓	No →	<b>Cool switch (S4) off.</b> Turn cool switch (S4) on. <b>Cool switch not wired.</b> Wire cool switch (S4). <i>If a cool switch is not required and a cooling inlet air sensor is provided, place jumper from R to Y1 to allow the cooling to enable based on the cooling inlet air sensor.</i>
24 VAC between terminal A2 and A1 on cooling relay (RC)?	Yes ↓	No →	<b>Optional inlet air sensor (TS4) holding.</b> Adjust TS4 setting. Reference Supply Fan, Start-Up. <b>Fan Interlock (ST1 or RF) open.</b> Refer to Troubleshooting, Supply Fan.
24 VAC between terminals 62 and 61?	Yes ↓	No →	<b>Auto drain transformer TR2 circuit breaker tripped.</b> Reset transformer circuit breaker. If circuit breaker continues to trip, inspect circuit for improper wiring or grounding. <b>Auto drain transformer TR2 failed.</b> Replace auto drain transformer.
24 VAC between terminals 7 and 61?	Yes ↓	No →	<b>Inlet air temperature below evap freeze protection sensor (FRZ) set point.</b> Allow inlet air temperature to rise above 55°F. <b>Evap freeze protection sensor (FRZ) not wired.</b> Wire evap freeze protection sensor. <b>Evap freeze protection sensor (FRZ) failed.</b> Replace evap freeze protection sensor.
Time ranges on auto drain timer set correctly?	Yes ↓	No →	<b>Set time ranges to the values shown on the ladder diagram.</b>
Auto drain timer in drain mode?	No ↓	Yes →	<b>Wait for the drain mode timer to expire (usually 10 minutes).</b>
24 VAC between terminals 8 and 61?	Yes ↓	No →	<b>Auto drain timer (TC) wiring issue.</b> Inspect and correct wiring issue. <b>Auto drain timer (TC) faulty.</b> Replace auto drain timer.



# Troubleshooting

## Evaporative Cooling

Evaporative cooling module sump filled?	Yes ↓	No →	<b>Auto drain valves (VS,VD,VSD) not wired.</b> Wire auto drain valves. <b>Auto drain valve(s) failed.</b> Replace failed valve(s).
24 VAC between terminals A2 and A1 on RA relay?	Yes ↓	No →	<b>Wiring issue to RA relay.</b> Inspect and correct wiring.
Line voltage at primary side of TR3?	Yes ↓	No →	<b>Transformer fuses (FU7) blown.</b> Check and replace blown fuse(s).
115 VAC between terminals 102 and 101?	Yes ↓	No →	<b>Transformer secondary fuses (FU8) blown.</b> Check and replace blown fuse(s). <b>Transformer TR3 wired incorrectly.</b> Refer to wiring diagram on transformer and correct wiring. <b>Transformer TR3 faulty.</b> Replace transformer.
115 VAC between terminal 14 on RC relay and 101?	Yes ↓	No →	<b>Auto drain relay (RA) failure.</b> Check for loose connections or bent relay pins, repair or replace relay.
115 VAC between terminals 116 and 101?	Yes ↓	No →	<b>Cooling relay (RC) failure.</b> Check for loose connections or bent relay pins, repair or replace relay.
Evaporative cooling pump(s) (P1) running?	Yes ↓	No →	<b>Evaporative cooling pump(s) (P1) wired incorrectly or not wired.</b> Correct any wiring Issues. <b>Evaporative cooling pump(s) (P1) faulty.</b> Replace evaporative cooling pump(s).

Everything is working properly, consult factory.

### Problem: Evaporative Cooling Module Does Not Operate - Single Pass Control

Is fan operating correctly?	Yes ↓	No →	<b>Refer to the Troubleshooting, Supply Fan.</b>
24 VAC between terminals Y1 and C	Yes ↓	No →	<b>Cool switch (S4) off.</b> Turn cool switch (S4) on. <b>Cool switch not wired.</b> Wire cool switch (S4). <i>(If a cool switch is not required and a cooling inlet air sensor is provided, place jumper from R to Y1 to allow the cooling to enable based on the cooling inlet air sensor).</i>
24 VAC between terminal A2 and A1 on cooling relay (RC)?	Yes ↓	No →	<b>Optional inlet air sensor (TS4) holding.</b> Adjust TS4 setting. Reference Supply Fan, Start-Up. <b>Fan Interlock (ST1 or RF) open.</b> Refer to Troubleshooting, Supply Fan.
24 VAC between terminals 62 and 61?	Yes ↓	No →	<b>Single pass transformer TR2 circuit breaker tripped.</b> Reset transformer circuit breaker. If circuit breaker continues to trip, inspect circuit for improper wiring or grounding. <b>Single pass transformer TR2 failed.</b> Replace cooling transformer.
24 VAC between terminals 8 and 61?	Yes ↓	No →	<b>Cooling relay (RC) failure.</b> Check for loose connections or bent relay pins, repair or replace relay.
Water flowing to media?	Yes ↓	No →	<b>Manual ball valve closed.</b> Open and adjust ball valve. <b>Single pass valves (VS, VSD) not wired.</b> Wire single pass valves. <b>Single pass valve(s) failed.</b> Replace failed valve(s).

Everything is working properly, consult factory.

### Problem: Water Blows through Evaporative Cooling Module

Are the headers in place and located near the entering air side of the media?	Yes ↓	No →	<b>Replace headers and/or move the headers.</b> Reference Start-Up: Optional Features, Evaporative Cooling Module.
Water supply to header too high?	No ↓	Yes →	<b>Use the header control valve to reduce the supply of water.</b>
Air velocity greater than specified?		Yes →	<b>Reduce the air velocity through the media.</b> Reference Supply Fan, Start-Up.

Everything is working properly, consult factory.



# Appendix A: Microprocessor Controller

## Start-up with Microprocessor Controller

This appendix provides additional information for performing the direct gas-fired heating start-up for units configured with the microprocessor controller. Please follow these steps and refer to the previous sections of this manual as instructed for additional information. Complete all the pre-start checks and the supply fan start-up before proceeding with the steps in this appendix.

### 1. DETERMINE THE AIRFLOW CONFIGURATION

Investigate the unit to determine the airflow configuration. This configuration will be used future steps. For example, if the unit is configuration B follow step 6B and skip steps 6A, and 6C

Configuration A is a constant volume configuration with fixed baffle plates that are bolted in place above and below the burner.

Configuration B is a variable volume configuration with a weighted barometric damper mounted in a bypass opening below the burner.

Configuration C is a recirculating configuration and the unit will have a return air damper located in the bottom of the filter section or a return air damper located after the burner. See the IOM section Start-Up: Direct Gas-Fired Heating > Optional Features > Recirculation Arrangements for more information.

### 2. CHECK THE SUPPLY GAS PRESSURE

Check the supply gas pressure and compare it with the unit's nameplate pressure requirements. Adjust the supply regulator as needed until the supply gas pressure is within the specified range. The nameplate is located on the outside of the unit on the control panel side.

### 3. ENABLE THE UNIT

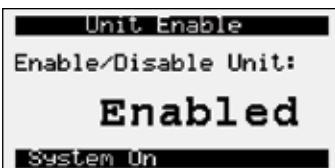

Enable the unit by connecting terminals R and G. Then navigate to the Unit Enable Menu in the microprocessor controller and change to Enabled. This will start the unit.

### 4. LOGIN WITH THE SERVICE PASSWORD

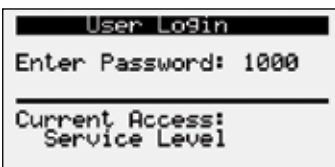

Navigate to the Ctrl Variables > Advanced > Login menu and enter in the service password = 1000. Once you are logged in the current access level shown on this menu will change from Read Only to Service Level and you will be taken back to the Advanced menu.

### 5. ENABLE MANUAL OVERRIDES

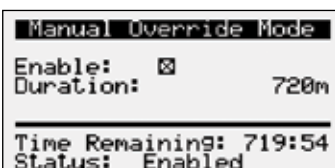

Scroll down to the Manual Overrides > Manual Override Mode menu. Change the empty enable box to be "checked" which will enable manual overrides.

### 6. SET THE BURNER AIR PRESSURE DIFFERENTIAL

With the control center open, all other access panels in place and the fan running, connect a manometer to the burner differential sensing probes and measure the static pressure across the burner. Proceed to the appropriate step for the airflow configuration identified in step 1.

#### 6A. Set the Burner Air Pressure Differential for Configuration A (Constant Volume)

Proper differential static pressure should read:

- Natural Gas: 0.625–0.675 in wg (156–168 Pa)



# Appendix A: Microprocessor Controller

## Start-up with Microprocessor Controller

- Liquid Propane (LP) Gas: 0.8–0.9 in wg (200–224 Pa)

The baffle plates were set at the factory for the correct airflow; thus, an incorrect reading typically is due to improper airflow. To increase pressure drop increase fan speed, by adjusting the VFD parameters (if equipped), closing the adjustable motor sheave (if equipped) or sheave replacement (if equipped).

To reduce pressure drop reduce fan speed, by opening the adjustable motor sheave (if equipped), sheave replacement (if equipped) or reducing the VFD speed. VFD speed can be reduced by navigating to the Ctrl Variables > Fan Control > Supply Fans > Supply Fan Constant Volume Setpt menu and reducing fan speed.



If test and balance has already been performed or fan speed cannot be adjusted, the burner baffle plates can be adjusted. Evenly adjust the baffles above and below the burner, keeping the burner centered in the opening until the required pressure is obtained. To increase the static pressure, decrease the opening. To decrease the static pressure, increase the opening.

When required pressure is obtained, be sure to reconnect the outer sensing probes.

### 6B. Set the Burner Air Pressure Differential for Configuration B (Variable Volume)

Static pressure will vary slightly as airflow changes on variable volume units. Override the supply fan speed to 100% by navigating to the Ctrl Variables > Advanced > Manual Overrides > Supply Fan menu. Change override to manual and speed to 100% and measure pressure differential. Then override fan speed to 50% and measure pressure differential. Both measurements should read:

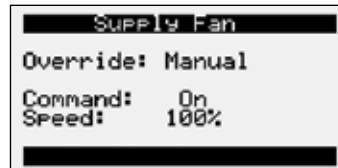

- Natural Gas: 0.5–0.8 in wg (156–168 Pa)
- Liquid Propane (LP) Gas: 0.7–1.0 in wg (200–224 Pa)

If pressure differential is too high at 100% reduce the fan speed to reduce pressure drop. If pressure drop is too low at 50% increase fan speed. Once minimum and maximum fan speeds have been determined adjust the minimum and maximum fan speeds in the Ctrl Variables > Fan Control > Supply Fans menu.

### 6C. Set the Burner Air Pressure Differential for Configuration C (Recirculation)

Burner pressure differential on units with recirculation is affected by total airflow and the percentage of airflow that is passing over the burner. If too much air is allowed to bypass the burner, the burner pressure differential will be too low. If too little air is allowed to bypass the burner, the burner pressure differential will be too high.

Burner pressure differential will vary slightly as the percentage of recirculated air varies. Override the damper position by navigating to the Ctrl Variables > Advanced > Manual Overrides > Outside Damper menu and change override to manual and adjust damper position %. Measure pressure differential with position at both 100% (100% outside air) and 0% (minimum 20% outside air). Verify pressure differential is in the correct range throughout the operating range of the recirculation damper:

- Natural Gas: 0.5–0.8 in. wg
- Liquid Propane (LP) Gas: 0.7–1.0 in. wg.

If adjustment is necessary, adjust the fan RPM via adjustable motor sheaves (if equipped) or sheave replacement to achieve proper burner pressure drop. Motor amp draw must not exceed full load amperage (FLA) on motor nameplate. If fan RPM cannot be adjusted or proper burner pressure differential cannot be achieved by adjusting fan RPM, adjust the baffle located over the recirculated air damper (non-filtered recirculation) or the baffle located under the burner in the bypass airstream (filtered recirculation). Adjusting the recirculated air damper baffles or bypass baffles will adjust the percentage of air that is allowed to bypass the burner. Close the baffle(s) to raise the burner pressure differential. Open the baffle(s) to lower the burner pressure differential. If the recirculated air damper baffles or bypass baffle are adjusted as far as they will go, adjust the baffles on either side of the burner as necessary.

# Appendix A: Microprocessor Controller

## Start-up with Microprocessor Controller

### 7. HEATING OVERRIDES

```
    DG Burner
Override: Manual
Command:   On
Demand:   0%
-----
OA: 67.9°F SA: 79.0°F
DG Burner On
```

#### **Heat Enable**

To enable the heating navigate to the Ctrl Variables > Advanced > Manual Overrides > DG Burner and change the override to manual and command on to enable heating. Once heat is enabled, proceed to step 2 in the IOM section Start-Up: Direct Gas-Fired Heating for the appropriate ignition controller.

```
    DG Burner
Override: Manual
Command:   On
Demand:  100%
-----
OA: 67.9°F SA: 118.7°F
DG Burner On
```

#### **Maximum Fire**

Setting override to manual, command to on and demand to 100% will send the burner to maximum fire. Once heat is set to maximum fire, proceed to step 3 in the IOM section Start-Up: Direct Gas-Fired Heating for the appropriate ignition controller. Supply air (SA) and outside air (OA) on this screen can be used to determine the temperature rise = SA – OA.

```
    Heating RAMP
Override: Manual
Demand:   1%
-----
DG Burner Off
```

#### **Minimum Fire**

Setting override to manual, command to on and demand to 0% will send the burner to minimum fire. Once heat is set to minimum fire, proceed to step 4 in the IOM section Start-Up: Direct Gas-Fired Heating for the appropriate ignition controller.

### 8. DISABLE OVERRIDES

```
    Manual Override Mode
Enable: 
Duration: 720m
-----
Time Remaining: 0:00
Status: Disabled
```

Once start-up is complete disable overrides by cycling power to the unit or navigating to the Ctrl Variables > Advanced > Manual Overrides menu and removing the check for the enable box, the status should change to “Disabled”.



## Typical Control Center Layout

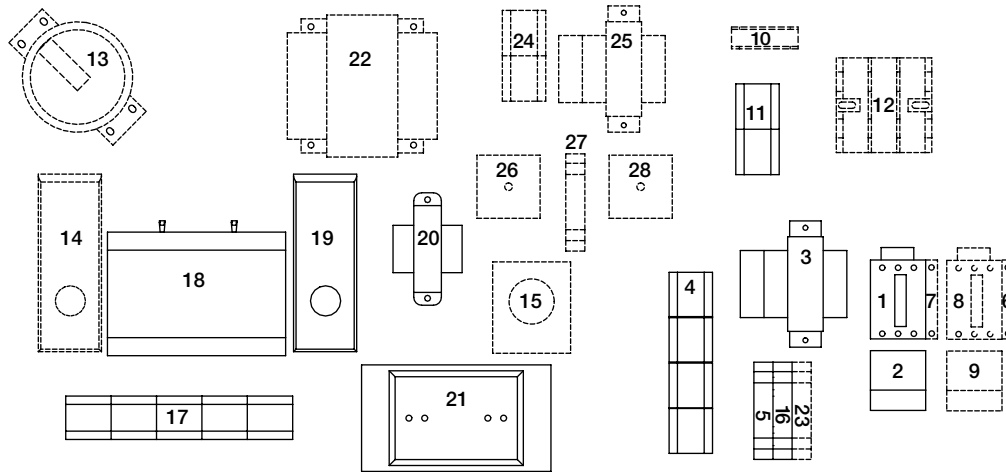

1. **Supply Motor Starter** — 24 volt magnetic contacts for starting supply motor.
2. **Supply Overload** — provides electronic overload protection to supply motor.
3. **Low Voltage Transformer** — provides low voltage to fan/heat/cooling enable controls.
4. **Control Terminal Block** — provides wiring access to controls.
5. **Fan Relay** — allows power to pass to energize motor starter.
6. **Exhaust Auxiliary Contact (optional)** — provides one normally closed and one normally open contact for other equipment.
7. **Supply Auxiliary Contact (optional)** — provides one normally closed and one normally open contact for other equipment.
8. **Exhaust Motor Starter (optional)** — 24 volt magnetic contacts for starting exhaust motor.
9. **Exhaust Overload (optional)** — provides electronic overload protection to exhaust motor.
10. **Transformer Fuse (optional)** — provides proper fusing for cooling transformer.
11. **Terminal Block** — provides wiring access to high voltage circuits.
12. **Exhaust Fuses (optional)** — provides proper fusing for exhaust fan motor(s).
13. **Dirty Filter Switch (optional)** — monitors filter pressure drop, turns on indicating light when pressure drop is above field-adjustable set point.
14. **Inlet Air Sensor (optional)** — outdoor air stat that automatically controls the heating and/or cooling based on outdoor air temperature.
15. **Remote Temperature Selector (optional)** — allows for remote temperature set point.
16. **Heat Relay** — allows power to pass to heating controls.
17. **Heating Terminal Block** — provides wiring access to heating controls.
18. **Flame Safeguard/Spark Generator** — monitors flame, shuts down unit when unsafe conditions are detected.
19. **High Limit** — prevents unit from discharging air above a set point.
20. **Low Voltage Transformer** — reduces voltage to Maxitrol system.
21. **Amplifier** — controls modulating valve, assures the desired temperature is delivered.
22. **Transformer (optional)** — provides voltage to optional evaporative cooling pump.
23. **Cooling Relay (optional)** — allows power to pass to cooling controls.
24. **Cooling Terminal Block (optional)** — provides wiring access to cooling controls.
25. **Low Voltage Transformer (optional)** — reduces voltage to cooling controls.
26. **Reset Timer (optional)** — resets cooling system to run a time interval.
27. **Auto Drain Relay (optional)** — assures supply pump does not operate during drain interval. Allows pump to operate in cooling mode.
28. **Cooling Timer (optional)** — allows for automatic draining of the evaporative cooling system based on time schedule.

# Reference

## Start-Up Checklist

Unit Model Number \_\_\_\_\_  
(e.g. XDGX-120-H32)

Unit Serial Number \_\_\_\_\_  
(e.g. 10111000)

Start-Up Date \_\_\_\_\_

Start-Up Personnel Name \_\_\_\_\_

Start-Up Company \_\_\_\_\_

Phone Number \_\_\_\_\_

### Pre Start-Up Checklist

*Check boxes as items are completed.*

- Check tightness of all factory wiring connections
- Verify control wiring wire gauge
- Hand-rotate fan to verify free rotation
- Verify supply voltage to the main disconnect
- Verify the supply gas pressure
- Verify remote controls wiring

### Start-Up Fan Checklist

- Check line voltage  
L1-L2 \_\_\_\_\_  
L2-L3 \_\_\_\_\_  
L1-L3 \_\_\_\_\_
- Check fan rotation
- Check for vibration
- Supply fan RPM \_\_\_\_\_ RPM
- Motor nameplate amps \_\_\_\_\_ Amps
- Actual motor  
L1 \_\_\_\_\_ Amps  
L2 \_\_\_\_\_ Amps  
L3 \_\_\_\_\_ Amps
- Actual CFM/kPA delivered \_\_\_\_\_ CFM/kPA

### Optional Accessories

- Heating Inlet Air Sensor  
\_\_\_\_\_ Actual Setting  
• *Typical setting 60°-70°F (15.6° - 21.1°C)*
- Cooling Inlet Air Sensor  
\_\_\_\_\_ Actual Setting  
• *Typical setting 75°F (23.9°C)*
- Building Freeze Protection  
• *Typical setting 5 minutes; 35°F (1.7°C)*
- Dirty Filter Gauge  
\_\_\_\_\_ Actual Setting  
• *Typical setting varies*

### Start-Up Direct Gas

*Refer to Start-Up: Direct Gas-Fired Heating section for further detail.*

- Check supply gas pressure  
\_\_\_\_\_ Maximum  
\_\_\_\_\_ Minimum  
\_\_\_\_\_ Actual
- Set optional High Gas Pressure Switch  
\_\_\_\_\_ Actual Setting  
• *Typical 8.0 in. wg (1 kPa)*
- Set optional Low Gas Pressure Switch  
\_\_\_\_\_ Actual Setting  
• *Typical 3.0 in. wg (0.75 kPa)*
- Set Burner Pressure Differential  
\_\_\_\_\_ Actual Setting  
• *Typical 0.65 in. wg (0.16 kPa)*
- Set the maximum firing rate  
\_\_\_\_\_ °F Temperature Rise
- Set the minimum firing rate  
\_\_\_\_\_ check
- Set the unit's operating temperature  
\_\_\_\_\_ °F

### Start-Up Evaporative Cooling (optional)

*Refer to Evaporative Cooling Start-Up section for further detail.*

- Check media orientation
- Check for proper water flow to distribution headers
- Check for distribution header orientation to prevent water spillage





# Reference

## Maintenance Log

Date \_\_\_\_\_ Time \_\_\_\_\_ AM/PM

Notes: \_\_\_\_\_  
\_\_\_\_\_  
\_\_\_\_\_  
\_\_\_\_\_

Date \_\_\_\_\_ Time \_\_\_\_\_ AM/PM

Notes: \_\_\_\_\_  
\_\_\_\_\_  
\_\_\_\_\_  
\_\_\_\_\_

Date \_\_\_\_\_ Time \_\_\_\_\_ AM/PM

Notes: \_\_\_\_\_  
\_\_\_\_\_  
\_\_\_\_\_  
\_\_\_\_\_

Date \_\_\_\_\_ Time \_\_\_\_\_ AM/PM

Notes: \_\_\_\_\_  
\_\_\_\_\_  
\_\_\_\_\_  
\_\_\_\_\_

Date \_\_\_\_\_ Time \_\_\_\_\_ AM/PM

Notes: \_\_\_\_\_  
\_\_\_\_\_  
\_\_\_\_\_  
\_\_\_\_\_

Date \_\_\_\_\_ Time \_\_\_\_\_ AM/PM

Notes: \_\_\_\_\_  
\_\_\_\_\_  
\_\_\_\_\_  
\_\_\_\_\_

Date \_\_\_\_\_ Time \_\_\_\_\_ AM/PM

Notes: \_\_\_\_\_  
\_\_\_\_\_  
\_\_\_\_\_  
\_\_\_\_\_

Date \_\_\_\_\_ Time \_\_\_\_\_ AM/PM

Notes: \_\_\_\_\_  
\_\_\_\_\_  
\_\_\_\_\_  
\_\_\_\_\_

Date \_\_\_\_\_ Time \_\_\_\_\_ AM/PM

Notes: \_\_\_\_\_  
\_\_\_\_\_  
\_\_\_\_\_  
\_\_\_\_\_

Date \_\_\_\_\_ Time \_\_\_\_\_ AM/PM

Notes: \_\_\_\_\_  
\_\_\_\_\_  
\_\_\_\_\_  
\_\_\_\_\_

Date \_\_\_\_\_ Time \_\_\_\_\_ AM/PM

Notes: \_\_\_\_\_  
\_\_\_\_\_  
\_\_\_\_\_  
\_\_\_\_\_

Date \_\_\_\_\_ Time \_\_\_\_\_ AM/PM

Notes: \_\_\_\_\_  
\_\_\_\_\_  
\_\_\_\_\_  
\_\_\_\_\_



**Reference**

**Maintenance Log**

Date \_\_\_\_\_ Time \_\_\_\_\_ AM/PM

Notes: \_\_\_\_\_  
\_\_\_\_\_  
\_\_\_\_\_  
\_\_\_\_\_

Date \_\_\_\_\_ Time \_\_\_\_\_ AM/PM

Notes: \_\_\_\_\_  
\_\_\_\_\_  
\_\_\_\_\_  
\_\_\_\_\_

Date \_\_\_\_\_ Time \_\_\_\_\_ AM/PM

Notes: \_\_\_\_\_  
\_\_\_\_\_  
\_\_\_\_\_  
\_\_\_\_\_

Date \_\_\_\_\_ Time \_\_\_\_\_ AM/PM

Notes: \_\_\_\_\_  
\_\_\_\_\_  
\_\_\_\_\_  
\_\_\_\_\_

Date \_\_\_\_\_ Time \_\_\_\_\_ AM/PM

Notes: \_\_\_\_\_  
\_\_\_\_\_  
\_\_\_\_\_  
\_\_\_\_\_

Date \_\_\_\_\_ Time \_\_\_\_\_ AM/PM

Notes: \_\_\_\_\_  
\_\_\_\_\_  
\_\_\_\_\_  
\_\_\_\_\_

Date \_\_\_\_\_ Time \_\_\_\_\_ AM/PM

Notes: \_\_\_\_\_  
\_\_\_\_\_  
\_\_\_\_\_  
\_\_\_\_\_

Date \_\_\_\_\_ Time \_\_\_\_\_ AM/PM

Notes: \_\_\_\_\_  
\_\_\_\_\_  
\_\_\_\_\_  
\_\_\_\_\_

Date \_\_\_\_\_ Time \_\_\_\_\_ AM/PM

Notes: \_\_\_\_\_  
\_\_\_\_\_  
\_\_\_\_\_  
\_\_\_\_\_

Date \_\_\_\_\_ Time \_\_\_\_\_ AM/PM

Notes: \_\_\_\_\_  
\_\_\_\_\_  
\_\_\_\_\_  
\_\_\_\_\_

Date \_\_\_\_\_ Time \_\_\_\_\_ AM/PM

Notes: \_\_\_\_\_  
\_\_\_\_\_  
\_\_\_\_\_  
\_\_\_\_\_

Date \_\_\_\_\_ Time \_\_\_\_\_ AM/PM

Notes: \_\_\_\_\_  
\_\_\_\_\_  
\_\_\_\_\_  
\_\_\_\_\_



# Reference

## Maintenance Log

Date \_\_\_\_\_ Time \_\_\_\_\_ AM/PM

Notes: \_\_\_\_\_  
\_\_\_\_\_  
\_\_\_\_\_  
\_\_\_\_\_

Date \_\_\_\_\_ Time \_\_\_\_\_ AM/PM

Notes: \_\_\_\_\_  
\_\_\_\_\_  
\_\_\_\_\_  
\_\_\_\_\_

Date \_\_\_\_\_ Time \_\_\_\_\_ AM/PM

Notes: \_\_\_\_\_  
\_\_\_\_\_  
\_\_\_\_\_  
\_\_\_\_\_

Date \_\_\_\_\_ Time \_\_\_\_\_ AM/PM

Notes: \_\_\_\_\_  
\_\_\_\_\_  
\_\_\_\_\_  
\_\_\_\_\_

Date \_\_\_\_\_ Time \_\_\_\_\_ AM/PM

Notes: \_\_\_\_\_  
\_\_\_\_\_  
\_\_\_\_\_  
\_\_\_\_\_

Date \_\_\_\_\_ Time \_\_\_\_\_ AM/PM

Notes: \_\_\_\_\_  
\_\_\_\_\_  
\_\_\_\_\_  
\_\_\_\_\_

Date \_\_\_\_\_ Time \_\_\_\_\_ AM/PM

Notes: \_\_\_\_\_  
\_\_\_\_\_  
\_\_\_\_\_  
\_\_\_\_\_

Date \_\_\_\_\_ Time \_\_\_\_\_ AM/PM

Notes: \_\_\_\_\_  
\_\_\_\_\_  
\_\_\_\_\_  
\_\_\_\_\_

Date \_\_\_\_\_ Time \_\_\_\_\_ AM/PM

Notes: \_\_\_\_\_  
\_\_\_\_\_  
\_\_\_\_\_  
\_\_\_\_\_

Date \_\_\_\_\_ Time \_\_\_\_\_ AM/PM

Notes: \_\_\_\_\_  
\_\_\_\_\_  
\_\_\_\_\_  
\_\_\_\_\_

Date \_\_\_\_\_ Time \_\_\_\_\_ AM/PM

Notes: \_\_\_\_\_  
\_\_\_\_\_  
\_\_\_\_\_  
\_\_\_\_\_

Date \_\_\_\_\_ Time \_\_\_\_\_ AM/PM

Notes: \_\_\_\_\_  
\_\_\_\_\_  
\_\_\_\_\_  
\_\_\_\_\_



## Our Commitment

---

*As a result of our commitment to continuous improvement, Accurex reserves the right to change specifications without notice.*

Product warranties can be found online at [accurex.com](https://accurex.com), either on the specific product page or in the Warranty section of the website at [Accurex.com/Resources/Warranty](https://accurex.com/Resources/Warranty).



P.O. Box 410 Schofield, WI 54476  
Phone: 800.333.1400 • Fax: 715.241.6191  
Parts: 800.355.5354 • [accurex.com](https://accurex.com)