

Quick Start Guide

XID and XIB Isolator Mounting

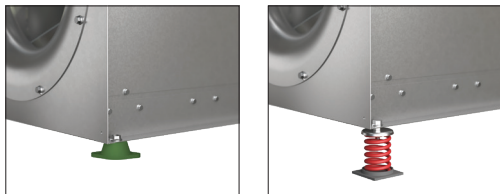

- This Quick Start Guide does not replace the Installation Operation Manual (IOM), refer to the IOM for more information

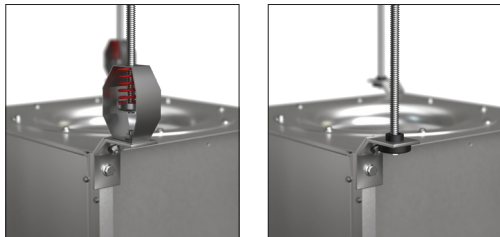
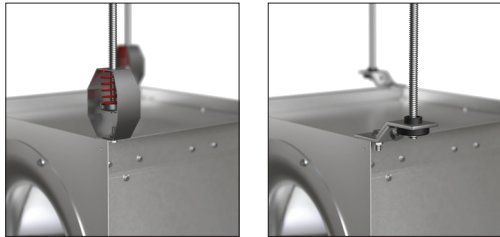

Mixed Flow Fan - XID Isolator Mounting

Move XID mixed flow fan to the desired location and determine the position in which the unit is to be mounted:

- For horizontal mount applications (excluding neoprene) mount the isolators directly to the fan
- For neoprene and vertical mount applications use supplied brackets

Make certain all fasteners are tight and that all washers are used

Vibration Isolator Dimensional Data			
Model	A	B	C
XID-7	12	13-1/8	19-3/4
XID-9	14	16-7/8	23-1/2
XID-12	17-1/2	20	26-5/8
XID-15	22	23-3/4	30-3/8
XID-16	23	25-3/4	32-3/8
XID-18	24-1/8	28-3/8	35
XID-20	26-5/8	31	37-5/8
XID-22	29-1/2	33-3/4	40-3/8
XID-24	33	37-1/4	43-7/8
XID-27	36-1/2	40-3/4	47-3/8
XID-30	40-1/2	44-3/4	51-3/8
XID-33	44-3/4	49	55-5/8

All dimensions in inches.

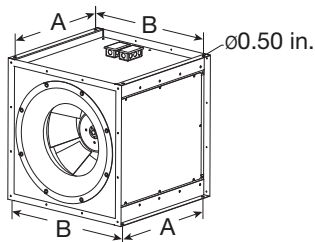

Horizontal Mount

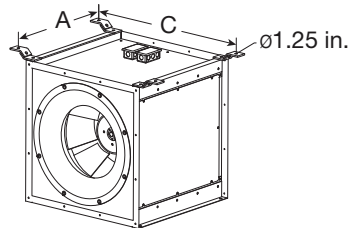

Horizontal Hanging Neoprene Mount

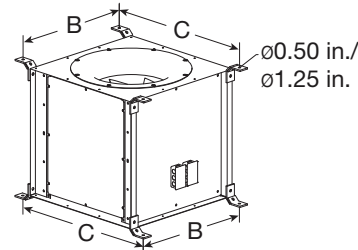

Vertical Mount

Mixed Flow Fan - XID Isolator Sizing

When isolators are selected with a unit they are sized based on the specific fan selection's weight



For replacement or retrofit isolators where the exact weight of the fan is unknown use the chart below to determine the appropriate isolator color and kit part number

Model	Mixed Flow Fan Size				
XID Mixed Flow	7-15	16-20	22-24	27-30	33
Approx. Weight (lbs)	0-150	150-300	300-500	500-700	700-1200
Isolator Type	Isolator Part Number				
Spring Hanging 1 inch	850343	850344	850345	850346	
Spring Hanging 2 inch	855858	855859	855860	855861	
Spring Base Mount	850347	850348	850349	850350	
Neoprene Hanging	855837	855838			
Neoprene Base Mount	855834		855835	855836	

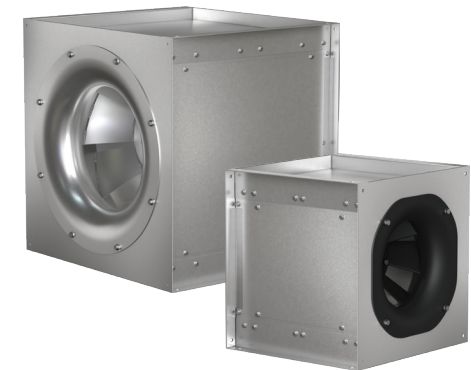

NOTE: XID and XIB centrifugal mounting information on reverse side

Centrifugal Fan - XID and XIB Isolator Mounting

For centrifugal XID and XIB, punch out (4) knock-out holes which are located on the unit top and bottom panels

Assemble the brackets to the unit according to the drawings shown to the right and refer to respective isolator sizing table

Make certain all fasteners are tight and that all washers are used

Vibration Isolator Dimensional Data				
Model	A	B	C	D
XID-60, 70	10-5/8	16-3/4	14-5/8	8-7/8
XID-80, 90, 95	13-1/4	19-3/4	15-1/8	9-3/8
XID-97, 98, 99	18-5/8	19-3/4	15-1/8	9-3/8
XID-100	18-5/8	21-3/4	19-5/8	13-7/8
XID-120	18-5/8	23-3/4	21-5/8	15-7/8
XID-130	18-5/8	25-3/4	23-5/8	17-7/8
XID-140	19-5/8	27-3/4	25-5/8	19-7/8
XID-160	23-1/2	31	28-3/4	22-7/8
XIB-70, 80, 90, 100	18	21-7/8	19-7/8	14-1/8
XIB-120	18	23-7/8	21-7/8	16-1/8
XIB-130	18	25-7/8	23-7/8	18-1/8
XIB-140	19	27-7/8	25-7/8	20-1/8
XIB-160	23	31-1/8	29	23-1/8
XIB-180	25	32-1/8	30	24-1/8
XIB-200	29	36-1/8	34	28-1/8
XIB-240	31	43-1/8	41	35-1/8
XIB-300	35	51	46 3/4	40-7/8
XIB-360	39-3/8	57	52-5/8	46-3/4
XIB-420	47	63	58-5/8	52-3/4

All dimensions in inches. High Pressure (HP) models share isolator dimensions with standard models.

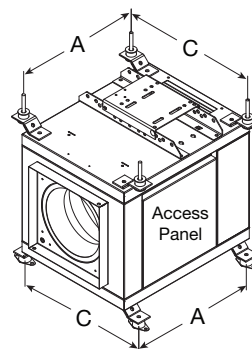
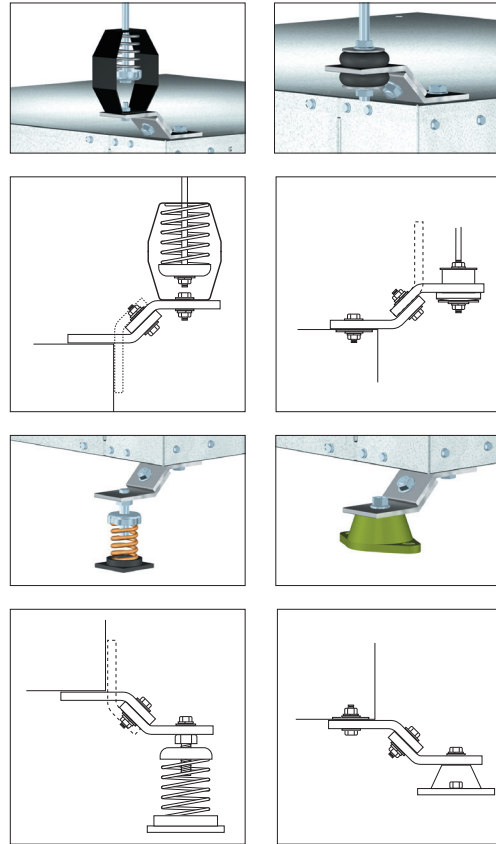

Horizontal Mount

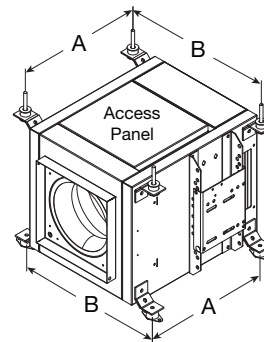

Horizontal Side Mount

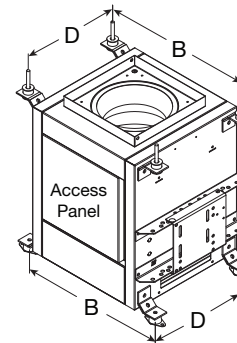

Vertical Mount

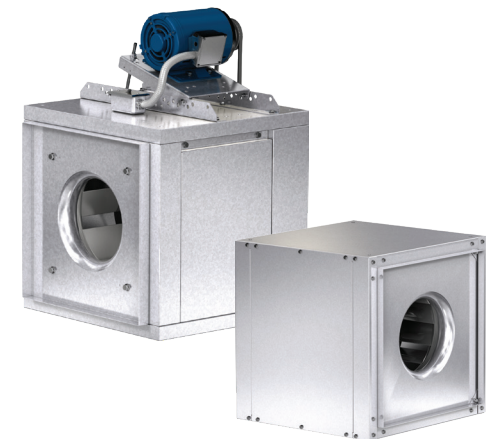

Centrifugal Fan - XID and XIB Isolator Sizing

When isolators are selected with a unit they are sized based on the specific fan selection's weight



For replacement or retrofit isolators where the exact weight of the fan is unknown use the chart below to determine the appropriate isolator color and kit part number

Model	Centrifugal Fan Size				
XID Centrifugal	60-140	160	-	-	-
XIB Centrifugal	70-140	160-200	240	300	360-420
Approx. Weight (lbs)	0-150	150-300	300-500	500-700	700-1200
Isolator Type	Isolator Part Number				
Spring Hanging 1 inch	850343	850344	850345	850346	
Spring Hanging 2 inch	855858	855859	855860	855861	
Spring Base Mount	850347	850348	850349	850350	
Neoprene Hanging	855837	855838			
Neoprene Base Mount	855834		855835	855836	

